



## **iT500 - FULL USER MANUAL**

**SALUS**  
CONTROLS

# TABLE OF CONTENTS

<b>1. Introduction</b>	<b>5</b>
1.1 Product Compliance	5
1.2 Safety Informations	5
<b>2. Product Overview</b>	<b>6</b>
2.1 Package content	7
2.2 Proper thermostat location	7
2.3 Connection Description	8
2.3.1 Wiring diagrams for single heating zone	8
A - Boiler control	8
B - Pump control in radiator heating system	8
C - Pump control in underfloor heating system	8
2.3.2 Wiring diagrams for single heating zone and hot water timer	9
A - Boiler (radiator system) and hot water pump control	9
B - Radiator system pump and hot water pump control	10
2.3.3 Wiring diagrams for two heating zones	12
2.4 Montage	15
2.4.1 Installation of wall bracket docking	15
2.4.2 Desk mount option iT500	15
2.4.3 Installation of iT500RX receiver	15
<b>3. Before you start (first power up)</b>	<b>16</b>
3.1 LCD icon description	16
3.2 Button description	16
3.3 iT500RX receiver switch functions	17
3.4 Inserting the batteries in the iT500 Thermostat	19
3.5 First power up sequence	20
<b>4. The pairing processes of the iT500 devices</b>	<b>21</b>
4.1 Pairing iT500TR with iT500RX receiver	21
4.2 Pairing iT300 (additional second zone sensor) with iT500TR thermostat	22
<b>5. About iT500 PLUS application</b>	<b>23</b>
5.1 Connecting the gateway to your existing router	23
5.2 Registration in the app	24
<b>6. Operating in ONLINE MODE (by app)</b>	<b>26</b>
6.1 General informations	26
6.2 App interface of the thermostat for heating zone	26
6.3 App interface of the thermostat for DHW control	27
6.4 Thermostat modes	28
6.4.1 Schedule mode for heating zone	28
6.4.2 Schedule mode for hot water system	29
6.4.3 Temporary override mode	30
6.4.4 Manual mode	30
6.4.5 Frost protection mode	31
6.5 Thermostat app settings	32
6.5.1 Clock format, time zone and DST setting	32
6.5.2 Heat/Cool mode change (app)	33
6.5.3 Holiday mode	35
6.5.4 Distance alerts	35
6.5.5 Factory Reset (removing thermostat from the app)	36

<b>7. Installation in OFFLINE MODE</b> .....	<b>37</b>
7.1 Identify your system type .....	37
7.2 System configuration selection .....	38
<b>8. Operating in OFFLINE MODE</b> .....	<b>40</b>
8.1 Operating modes.....	40
8.2 Setpoint temperature change (manual mode) .....	40
8.3 Schedule mode.....	41
8.3.1 Schedule mode for heating zone.....	41
8.3.2 Schedule mode for hot water system .....	42
8.3.3 Default schedules.....	43
8.4 Temporary override mode .....	44
8.5 Key lock function  .....	44
8.6 User settings .....	45
8.6.1 Setting the time and date .....	45
8.6.2 Heat/Cool mode change.....	45
8.6.3 Time zone selection.....	46
8.6.4 Daylight Saving Time setting.....	46
8.6.5 Hysteresis (SPAN) setting .....	47
8.6.6 Display temperature accuracy .....	47
8.6.7 Thermostat calibration (OFFS) .....	48
<b>9. Error codes</b> .....	<b>48</b>
<b>10. Temperatures outside operating range</b> .....	<b>49</b>
<b>11. Failsafe mode</b> .....	<b>49</b>
<b>12. Cleaning and Maintenance</b> .....	<b>50</b>
<b>13. Technical Informations</b> .....	<b>50</b>
<b>14. Warranty</b> .....	<b>51</b>



## 1. Introduction

### 1.1 Product Compliance

This product complies with the essential requirements and other relevant provisions of Directives 2014/53/EU and 2011/65/EU. The full text of the EU Declaration of Conformity is available at the following internet address: [www.saluslegal.com](http://www.saluslegal.com).

### 1.2 Safety Informations

- Before starting installation work and before using the product, read the entire manual.
- The information contained in the instructions is essential for proper functioning.
- To avoid accidents resulting in personal injury and material damage, please follow all safety precautions, specified in this manual.
- The device should not be used by people with limited mental, sensory or mental abilities, without experience, of insufficient knowledge as well as children.
- Do not use an unassembled device (eg without a cover).
- The device may only be opened by a qualified person.
- Keep electrical devices out of the reach of children and ensure that they do not play with it. Children should not be left unattended. If necessary, disconnect the control system for the entire room.
- Do not leave the packaging, cabinet, or any loose parts of the device unattended, as they pose a risk to children.

#### **WARNING!**

- Installation must be carried out by a qualified person with appropriate electrical qualifications in accordance with standards and regulations in force in the given country and in the EU.
- Never try to connect the device other than as described in the manual.
- Before assembly, repair or maintenance as well as during any connection works it is absolutely necessary disconnect the mains supply and make sure that the terminals and electric wires are not live.
- The device may not be exposed to extreme temperatures, strong vibrations or subjected to mechanical shock.
- The device should not be used in unfavorable environmental conditions or in rooms where there is a concentration of flammable gases, fumes or dust.

#### **WARNING!**

- There may be additional protection requirements for the entire installation that the installer is responsible for maintaining.



Care for the natural environment is of paramount importance to us. The awareness that we manufacture electronic devices obliges us to dispose of used electronic components and devices safely. Therefore the company has received a registration number issued by the Chief Inspector for Environmental Protection. The crossed out symbol the trash can on the product means that the product must not be disposed of with ordinary waste containers. Sorting waste for recycling helps to protect the environment. It is the user's responsibility to surrender used equipment to a designated collection point for recycling waste from electrical and electronic equipment.

## 2. Product Overview

The **SALUS iT500** is an internet thermostat that gives you complete freedom to manage the ambient temperature levels in your home, even when you are not physically at home. IT500 allows to control home temperature through the device or via Internet (mobile app).

### Product advantages of the Salus iT500 thermostat:

- **SALUS iT500 it's a home**, ambient temperature thermostat with immediate access to all functions using a smartphone, computer or tablet;
- **Incredibly clear and intuitive programming** - it is very easy to set / change temperature setpoints or thermostat's modes;
- Free, dedicated mobile applications - **for Android and iOS systems**;
- **Practical functions and features like:** time/temperature schedules (for whole week, individual days or working days + weekends), holiday mode, frost protection mode, geolocation function;
- Different kinds of control algorithms to choose including TPI (recommended for underfloor heating systems) and Hysteresis (from +/- 0.25°C to +/-2°C values);
- Can be used in Heating or Cooling systems, allows to re-calibrate measured temperature or change the accuracy of displayed temperature (in 0.5°C or 0.1°C temperature scales).

### Three device configuration options:

- **1.A** One heating zone („CH" output is active).
- **1.B** Two heating zones („CH" and „AUX" outputs are active). This configuration requires additional temperature sensor IT300.
- **1.C** One heating zone + domestic hot water control („CH" and „AUX" outputs are active).



**Note:** IT300 temperature sensor required for two heating zones must be purchased separately.

## 2.1 Package content



## 2.2 Proper thermostat location

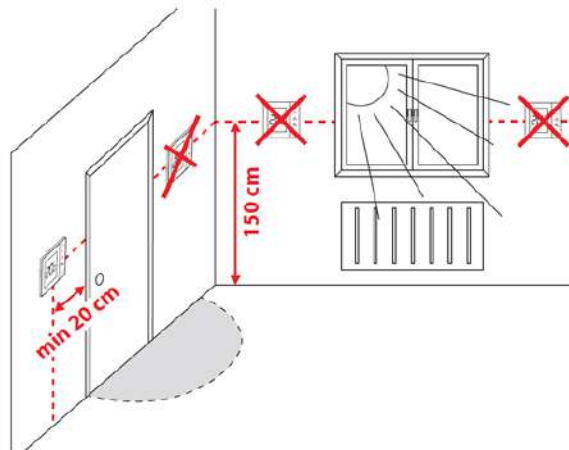

**Please note:**

**The ideal position to thermostat mounting is about 1,5m under floor level far from heating or cooling sources. Thermostat can't be exposed to sunlight or any extreme conditions like for example draft.**

Because of fire and explosion risk there is not allowed to use thermostat in atmosphere of explosive gases and flammable liquids (eg coal dust). In case if any of listed dangers occur you have to use additional protection measures – anti-dust and explosive gases (tight cover) or prevent their formation. Furthermore, thermostat can't be used in condensation of water vapor conditions and be exposed to water action.

## 2.3 Connection Description

### 2.3.1 Wiring diagrams for single heating zone

#### A - Boiler control

Hydraulic diagram:

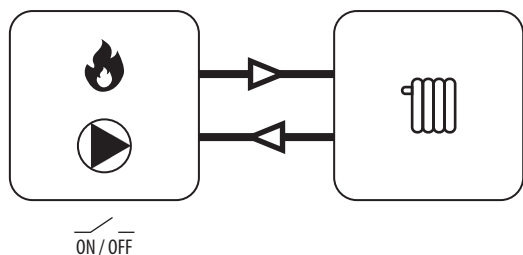

Electric diagram:

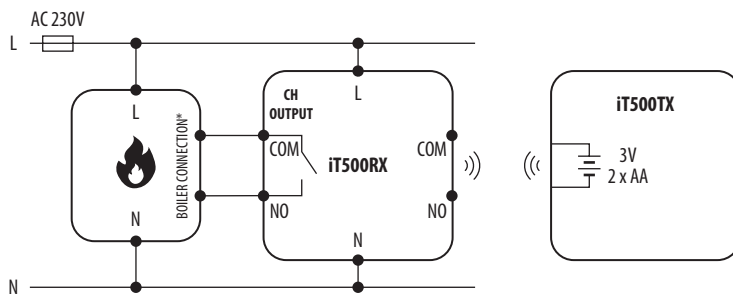

#### B - Pump control in radiator heating system

Hydraulic diagram:

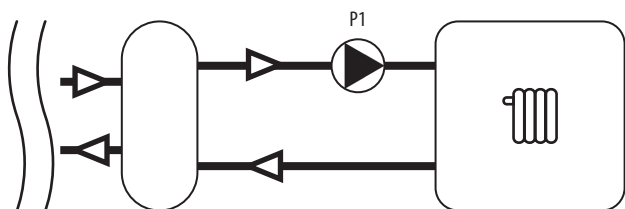

Electric diagram:

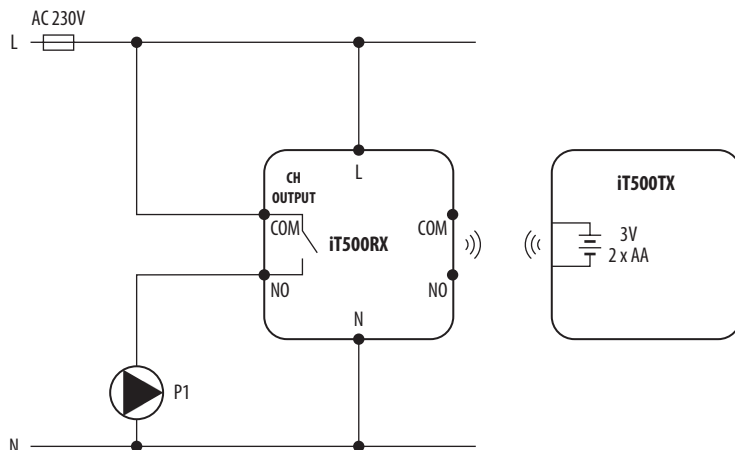

#### C - Pump control in underfloor heating system

Hydraulic diagram:

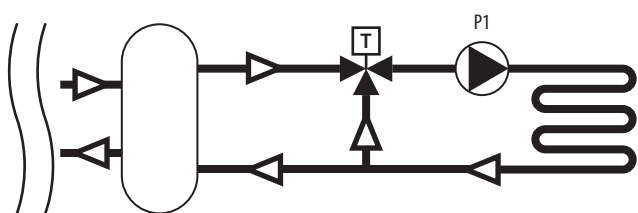

#### Legend:



**Boiler - Boiler connection\***  
- Boiler's contacts for ON/OFF thermostat (according to the boiler's instructions)



Thermostatic mixing valve

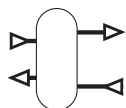

Buffer / Clutch



Radiator heating



Pump



Underfloor heating

#### Symbols explanation:

L, N - power supply 230V

NO, COM - voltage-free output

- fuse



## 2.3.2 Wiring diagrams for single heating zone and hot water timer

### A - Boiler (radiator system) and hot water pump control

Hydraulic diagram:

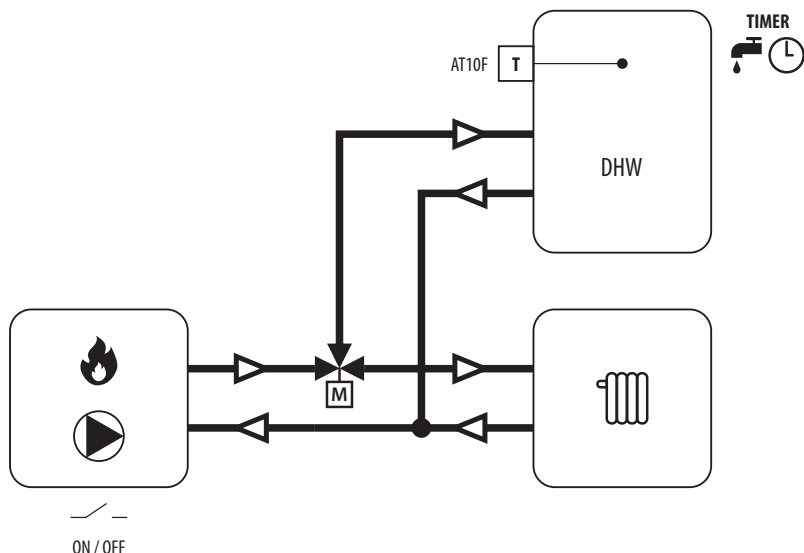

Electric diagram:

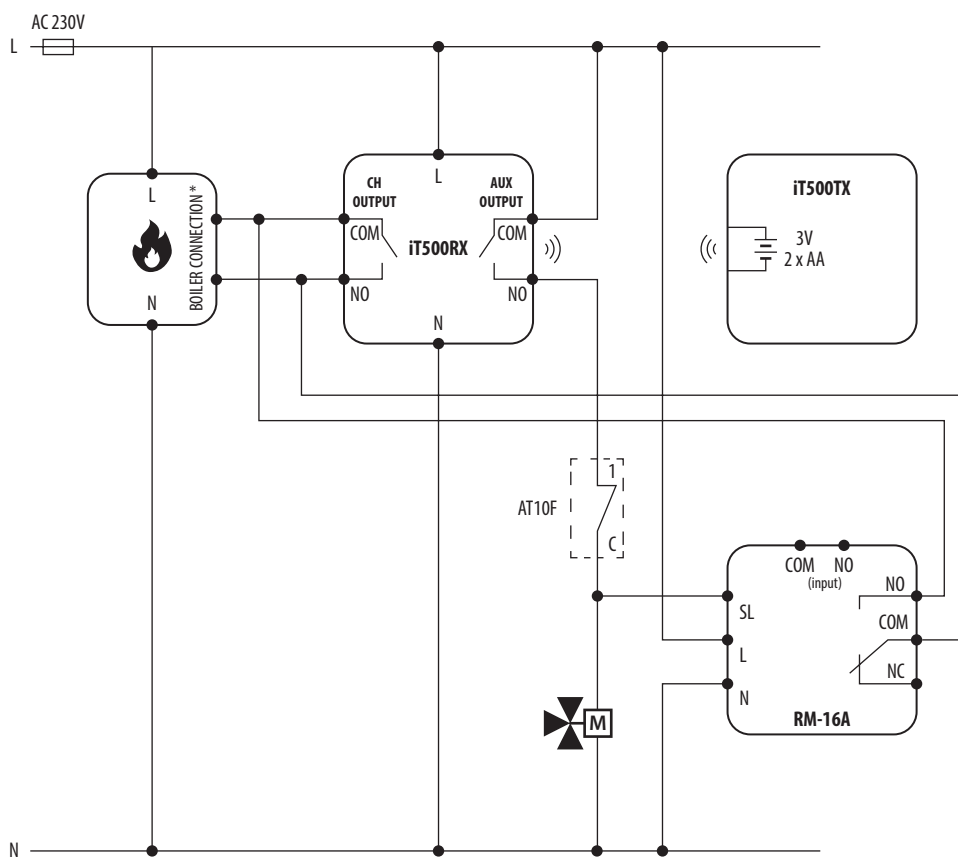

#### Legend:



**Boiler - Boiler connection\***  
- Boiler's contacts for ON/OFF thermostat (according to the boiler's instructions)



DHW immersion thermostat



Radiator heating



Changeover valve



Hot water tank



Pump

#### Symbols explanation:

L, N - power supply 230V

NO, COM, NC - voltage-free output

SL - 230V AC voltage output

- fuse

**B - Radiator system pump and hot water pump control (pumps parallel operation or with DHW priority)**

Hydraulic diagram:

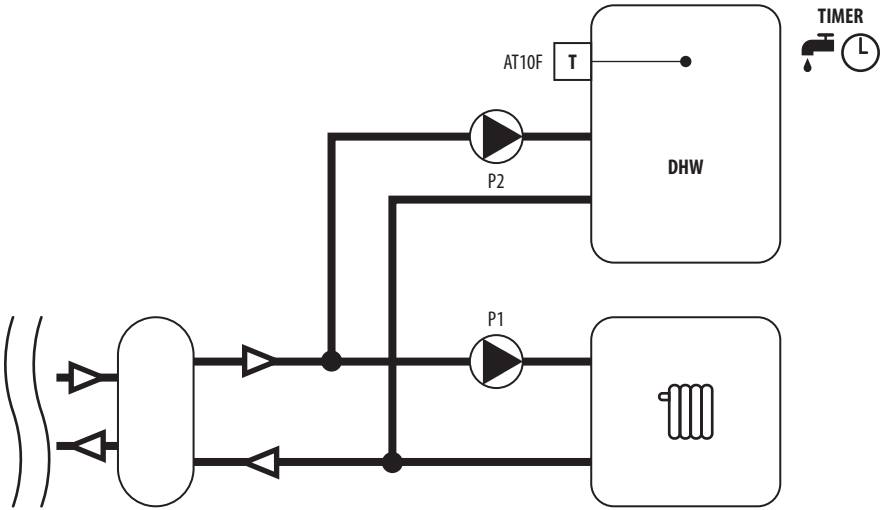

Electric diagram:

Parallel operation of pumps:

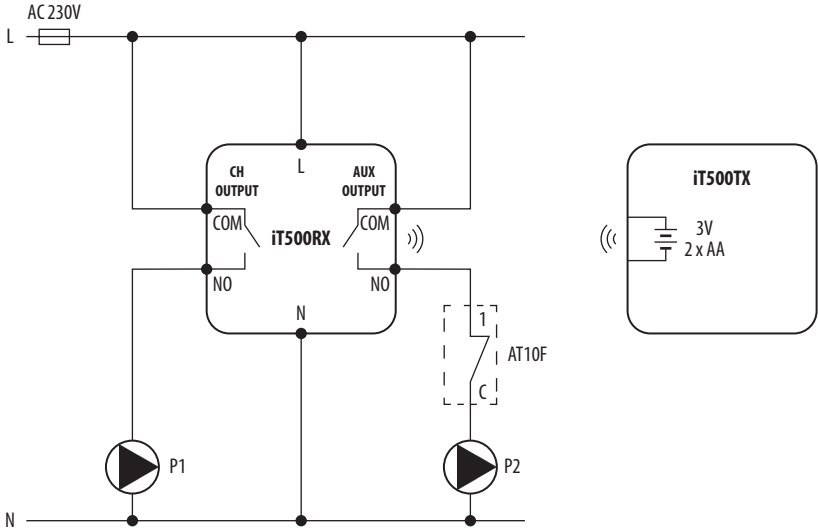

DHW priority:

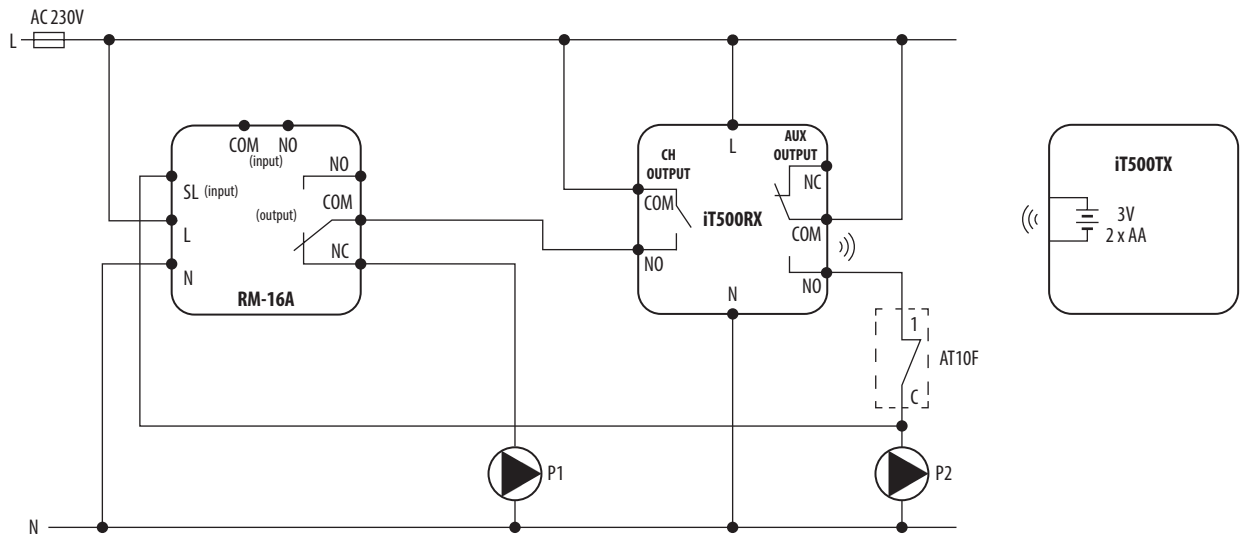

**Legend:**

**Symbols explanation:**

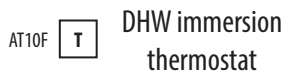
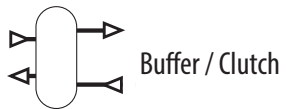

**L, N** - power supply 230V

**NO, COM, NC** - voltage-free output

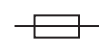
 - fuse

### 2.3.3 Wiring diagrams for two heating zones

**A**

Hydraulic diagram:

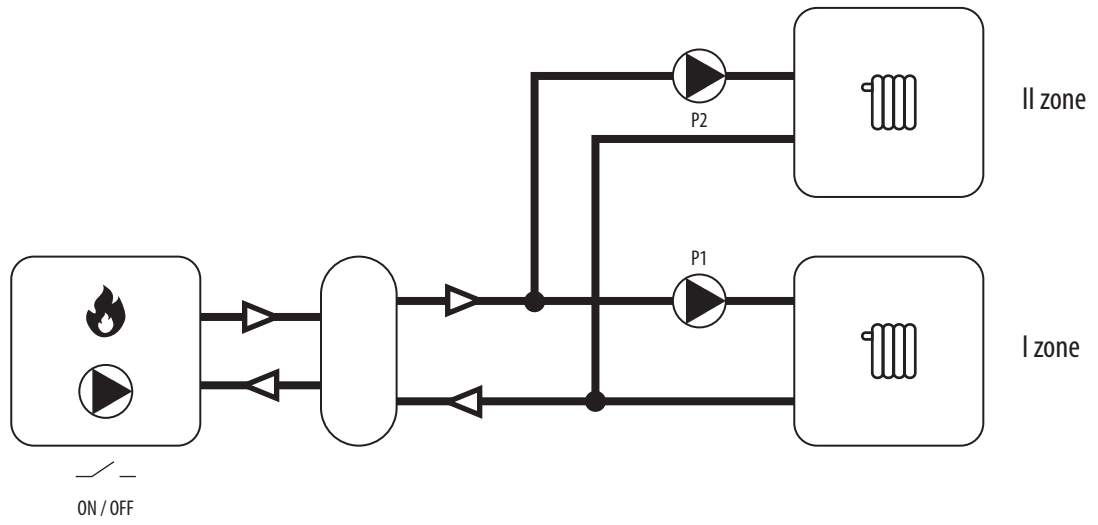

**B**

Hydraulic diagram:

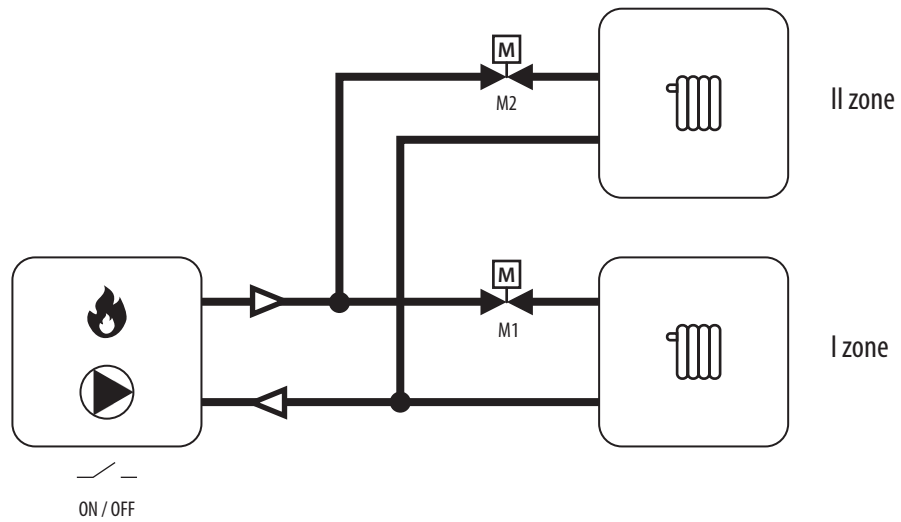

C

Hydraulic diagram:

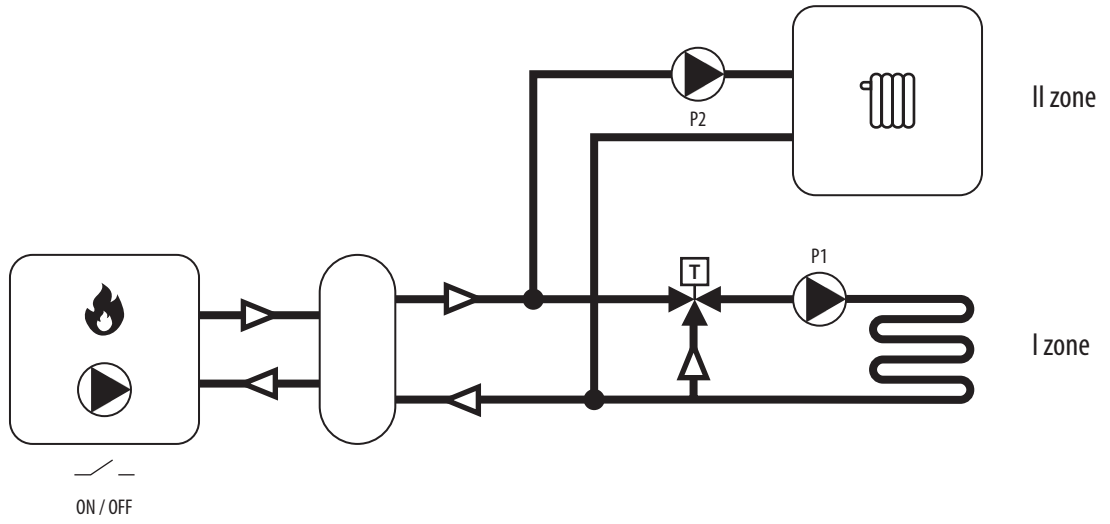

D

Hydraulic diagram:

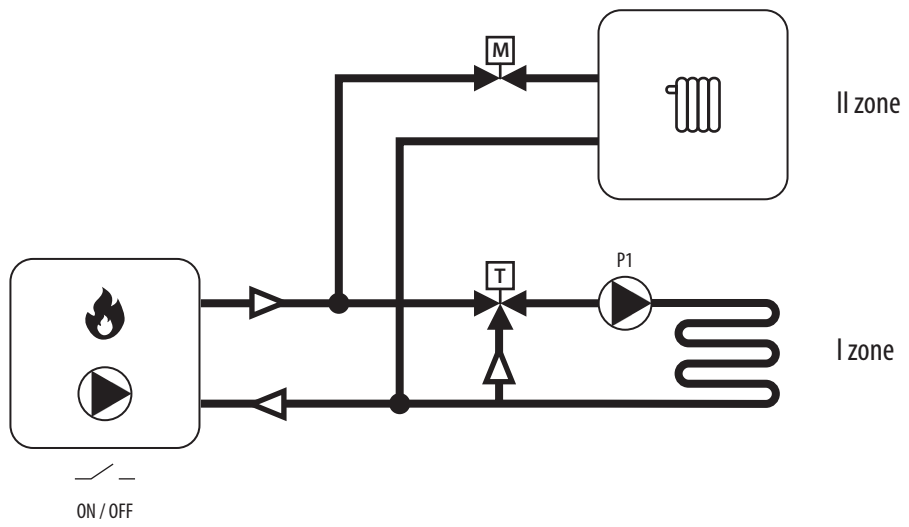

## Electric diagram:

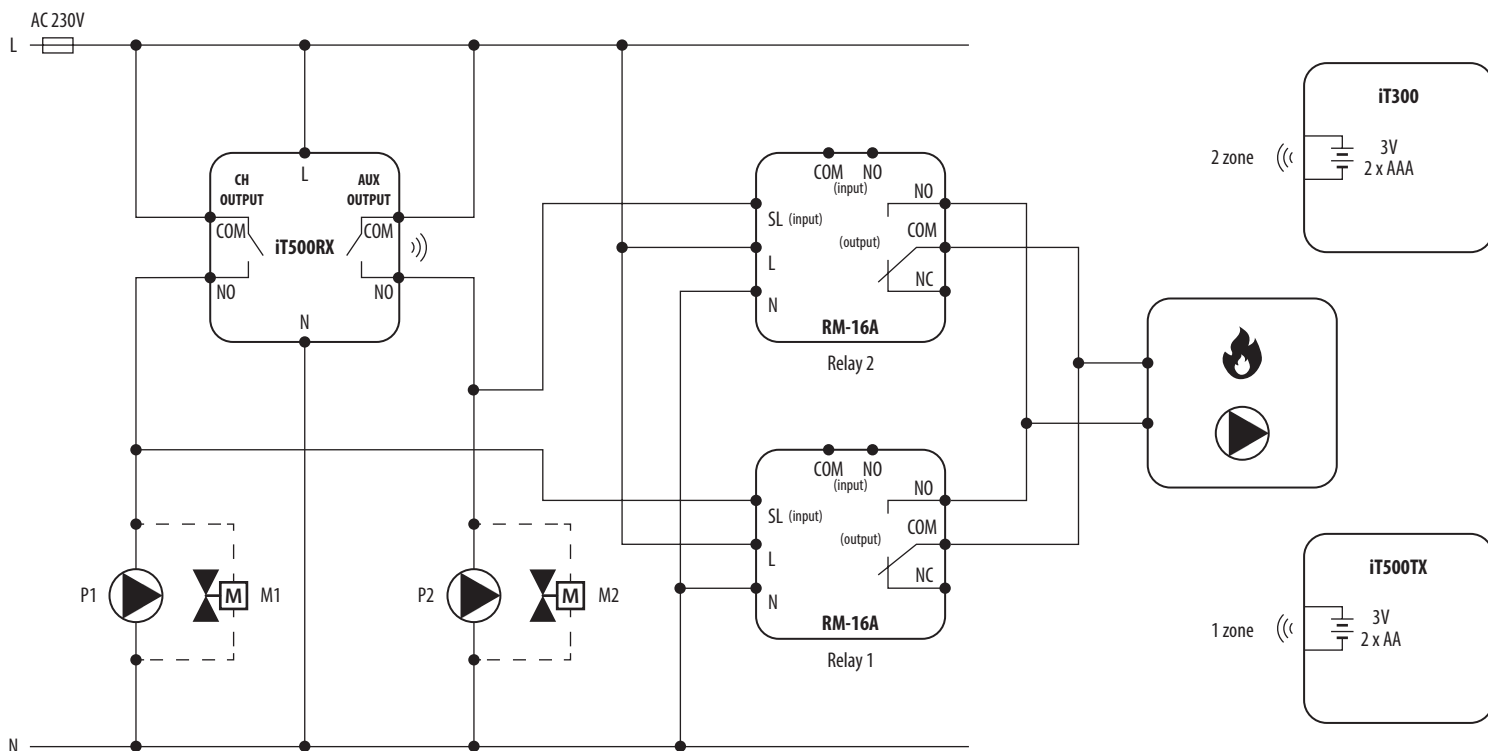

\* Relays **RM-16A** No. 1 and No. 2 are used only when we want to control the boiler (ON / OFF). Then connect the relay output contacts to the boiler in the place intended for connecting the room thermostat.

### Legend:

### Symbols explanation:



**Boiler - Boiler connection\***  
- Boiler's contacts for ON/OFF thermostat (according to the boiler's instructions)



Thermostatic mixing valve

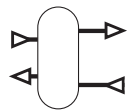

Buffer / Clutch



Radiator heating



Pump



Underfloor heating



Shut-off valve

**L, N** - power supply 230V

**NO, COM** - voltage-free output

- fuse

## 2.4 Montage

### 2.4.1 Installation of wall bracket docking



Attach the wall mounting bracket to a suitable wall using the fittings supplied and the built in spirit level.

After first ensuring that the bracket is secure, clip the iT500 into place by aligning the recess on the back of the unit to the bracket and clipping into place.

Once clipped into place, ensure the unit is securely seated on the bracket.

### 2.4.2 Desk mount option iT500



For the desk mounted option, simply clip the clear stand supplied separately into the back of the unit.

### 2.4.3 Installation of iT500RX receiver



**Note:** Always shut off the AC mains supply before installing or working on any components.

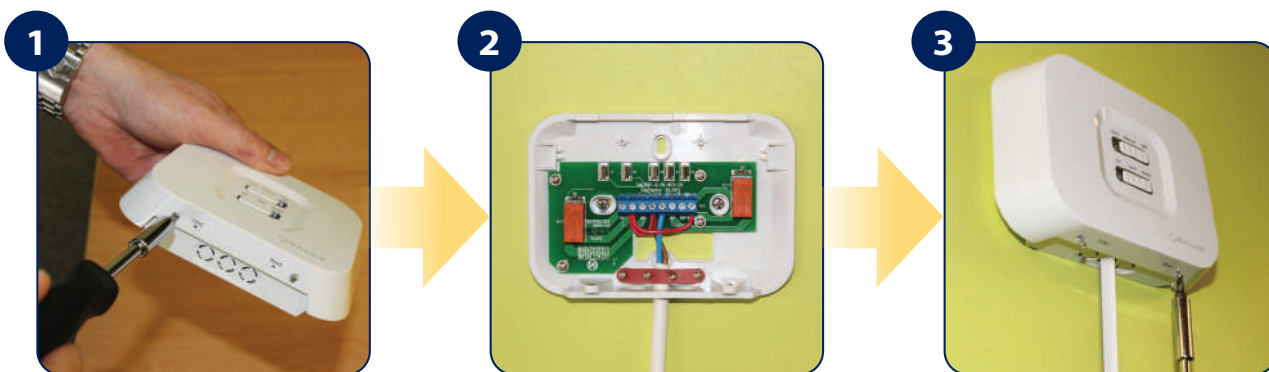

Loosen the screws at the bottom of the receiver unit and unclip the front of the unit.

Fit the back of the receiver unit to the wall using the fittings supplied. Then wire up the receiver using proper diagram.

Clip the front of the unit back and securely screw the front of the receiver in place.

### 3. Before you start (first power up)

#### 3.1 LCD icon description

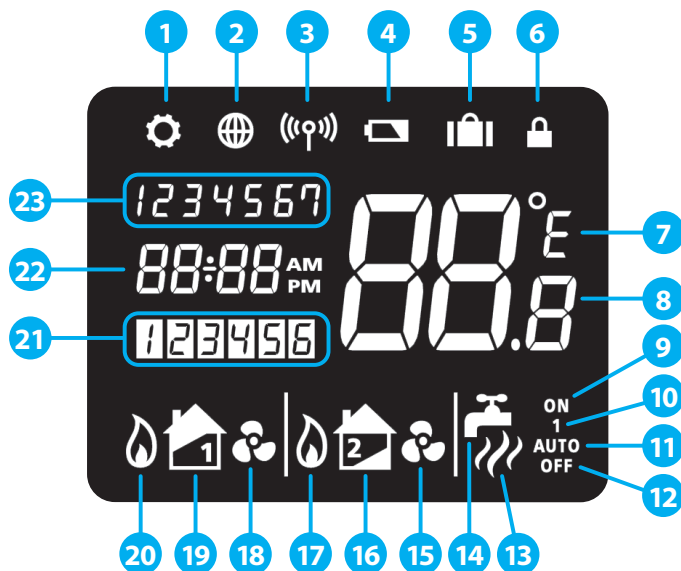

- |                                         |                                     |
|-----------------------------------------|-------------------------------------|
| 1. Settings indicator                   | 12. Frost protection mode           |
| 2. Internet connection indicator        | 13. Hot water heating               |
| 3. RF signal indicator                  | 14. Hot water indicator             |
| 4. Low battery status                   | 15. Cooling mode indicator (zone 2) |
| 5. Holiday indicator                    | 16. Zone 2 indicator                |
| 6. Button lock indicator                | 17. Heat mode indicator (zone 2)    |
| 7. Temperature unit                     | 18. Cooling mode indicator (zone 1) |
| 8. Temperature indicator                | 19. Zone 1 indicator                |
| 9. Hot water heating in continuous mode | 20. Heat mode indicator (zone 1)    |
| 10. Hot water override                  | 21. Program number indicator        |
| 11. Automatic mode                      | 22. Clock display                   |
|                                         | 23. Day of the week                 |

#### 3.2 Button description

Button Description	
Button	Function
✓	Confirm
↶	Return
⚙	Settings / zone changing
⤴	Increase value
⓪	Display ON (display highlighting)
⤵	Decrease value
Button combinations	Function
✓ + ↶	Press and hold for 3 seconds lock / unlock the device
↶ + ⚙	Press and hold for 3 seconds to enter the pairing mode (for IT500RX receiver or IT300 temperature sensor)
⚙ + ⤴	Press and hold for 3 seconds to enter the system operation choice: Zone1 or Zone1 + Hot Water or Zone1 + Zone2
⚙ + ✓	Press and hold for 3 seconds to enter the Auto/OFF/Manual mode change
⚙	Press and hold for 3 seconds to edit the schedule



### 3.3 iT500RX receiver switch functions



1. **AUTO** - receiver operate in automatic mode (works according to thermostat or app)
2. **MANUAL** - receiver operate according to the switch located below
3. **OFF** - receiver is disabled
4. **CH** - in manual mode, zone 1 is turned ON
5. **AUX** - in manual mode, zone 2 (or DHW) is turned ON
6. **CH/AUX** - in manual mode, zone 1 and zone 2 (or DHW) are turned ON

#### Receiver possible LED colours:



A detailed explanation of the meaning of the receiver LEDs can be found in the table below:

	Description
<b>The blue LED flashes</b>	Blue LED is flashing in 1Hz when it's set to Auto position and device is on.
<b>The yellow LED lights up</b>	Yellow LED turns on when the receiver is in fail safe mode (lost signal from the thermostat). It will lights up only when the receiver lost signal for more than one hour.
<b>The green LED lights up</b>	When the receiver is powered on.  (or)  After receiving correct signal from the thermostat.
<b>The green LED flashes</b>	Green LED is flashing in 0.5Hz for 4 seconds after receiving the correct adress and RF signal during pairing process from the thermostat in Auto mode.
<b>The red LED lights up</b>	When thermostat enters pairing process.
<b>The red LED flashes</b>	When pairing process has failed.

### 3.4 Inserting the batteries in the iT500 Thermostat



1 Remove the battery cover from the base of the iT500 Thermostat.

2 Make a note of the serial number printed inside the base of the iT500 Thermostat.

3 With the unit face down, insert the first battery supplied into the right hand side of the base of the iT500 Thermostat.

 You can make a note of your STA number here for future reference:

S	T	A																	
---	---	---	--	--	--	--	--	--	--	--	--	--	--	--	--	--	--	--	--



4 Insert the second battery supplied into the left hand side of the base of the iT500 Thermostat.

5 Ensure the batteries are fitted securely in the base of the iT500 Thermostat.

6 Replace the battery cover to the base of the iT500 Thermostat.

### 3.5 First power up sequence



To power on the thermostat you have to put in batteries, then display will show firmware version number...



...all icons will be displayed...

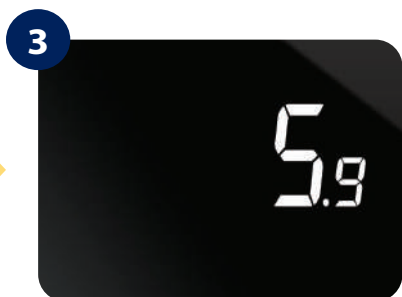
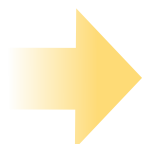

...then thermostat will display the software version.

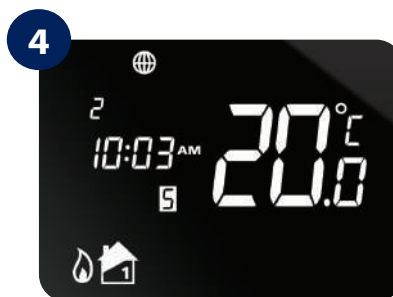

The globe icon  will appear when the unit automatically connects to the internet via the SALUS iTG500 Gateway. This should take approximately 20 seconds.

## 4. The pairing processes of the iT500 devices

### 4.1 Pairing iT500TR with iT500RX receiver



#### PLEASE NOTE!

**THE iT500TR THERMOSTAT MUST BE PAIRED WITH THE iT500RX RECEIVER!**



Use a thin object (such as a paper clip) to press and hold the SYNC button on the bottom of the iT500RX receiver for 5 seconds.



The bottom switch will show a constant red light when iT500RX receiver is ready to pair. Now go to iT500TR thermostat.



Press the power button  to highlight the display.



Press and hold  and  buttons for 3 sec.

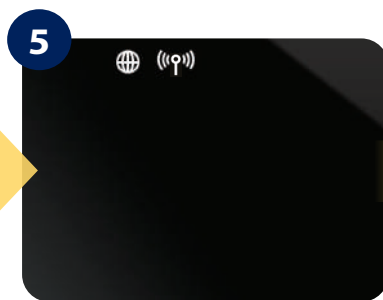

Press  button to launch pairing process.

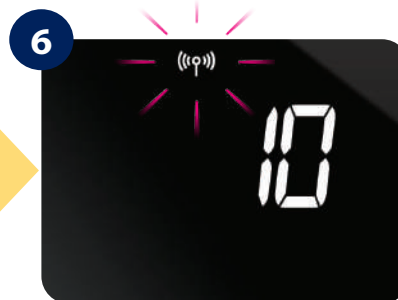



Pairing process can take up to 10 minutes.



When iT500RX receiver and iT500TR thermostat are paired then the light will be green.



Press  or  to return to the home screen.

## 4.2 Pairing iT300 (additional second zone sensor) with iT500TR thermostat

If you want to control the system with more than one heating zone, then iT300 is necessary to be installed. iT300 works as an additional sensor. Paired with iT500TR gives you a possibility to control it directly from the iT500TR thermostat. The iT300 should be installed in the area of the house that the second zone will be controlled from, ie. second floor, to measure proper temperature for the right place.

 **Note:** iT300 is purchased separately. Can only be used if your system supports second central heating zone.



1 Using a paper clip, hold for 3 seconds button which is located in the hole on the iT300 housing.



2 Red LED will start flashing means iT300 is ready to pair. Go to iT500TR thermostat.



3 Press the power button  to highlight the display.



4 Press and hold  and  buttons for 3 sec.

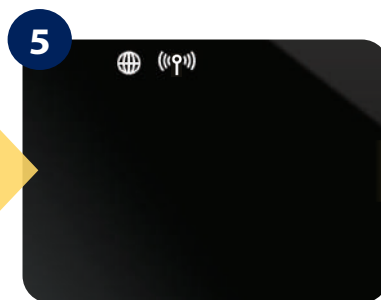

5 Press  button to launch pairing process.

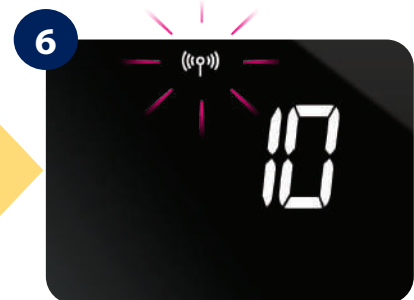

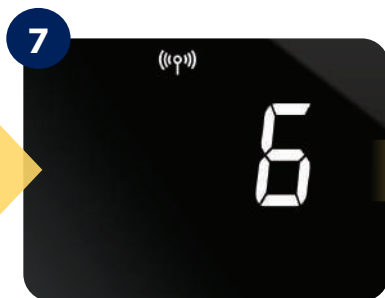

6 Pairing process can take up to 10 minutes.



7 iT500 has successfully paired with iT300 when the antenna stops flashing.



8 Press  or  to return to the home screen.



Please note the red LED on the iT300 can continue to flash and eventually timeout.

## 5. About iT500 PLUS application

Download the iT500 Plus app, create an account and register your device. Follow the on screen instructions to complete all the steps.

Features available only on the App:

- HOLIDAY mode
- Frost protection temperature setpoint change
- Simplified schedule wizard



iT500 Plus



You can add a few iT500 thermostats to one account.



Easy to use interface.



Simple to modify heating schedules. Choose from ALL, 5/2 or INDIVIDUAL days.



With walk through tutorials on how to use the App.

### 5.1 Connecting the gateway to your existing router

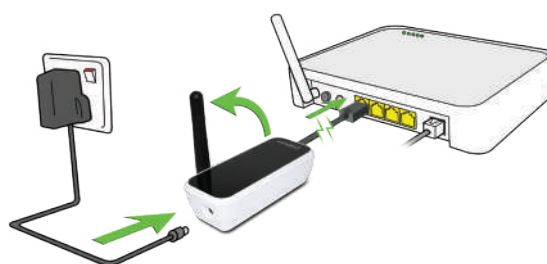

Red light indicates there is no connection with Internet



Green light indicates iTG500 connected with Internet and Salus Controls Server.



**Please note:**

If the LED on the iTG500 Internet Gateway is continuously red - check the Internet connection, router settings or contact your ISP. The correct operation of the gate and the application depends on the fulfillment of the following conditions:

- 1) The iTG310 Internet gateway must be connected to the LAN output of the router.
- 2) None of the ports: UDP 80, TCP 80, 2165, 2155, 3155 can be blocked.
- 3) PoE (power over ethernet) function in LAN output must be disabled.
- 4) Internet router should include 10/100 auto-negotiation (applies to fiber optic routers and high-speed Internet routers).
- 5) Some routers, eg the AVM Fritzbox 79xx series, cannot be connected to the gateway with a standard (straight) Ethernet cable. In this case, use an Ethernet crossover cable.

## 5.2 Registration in the app

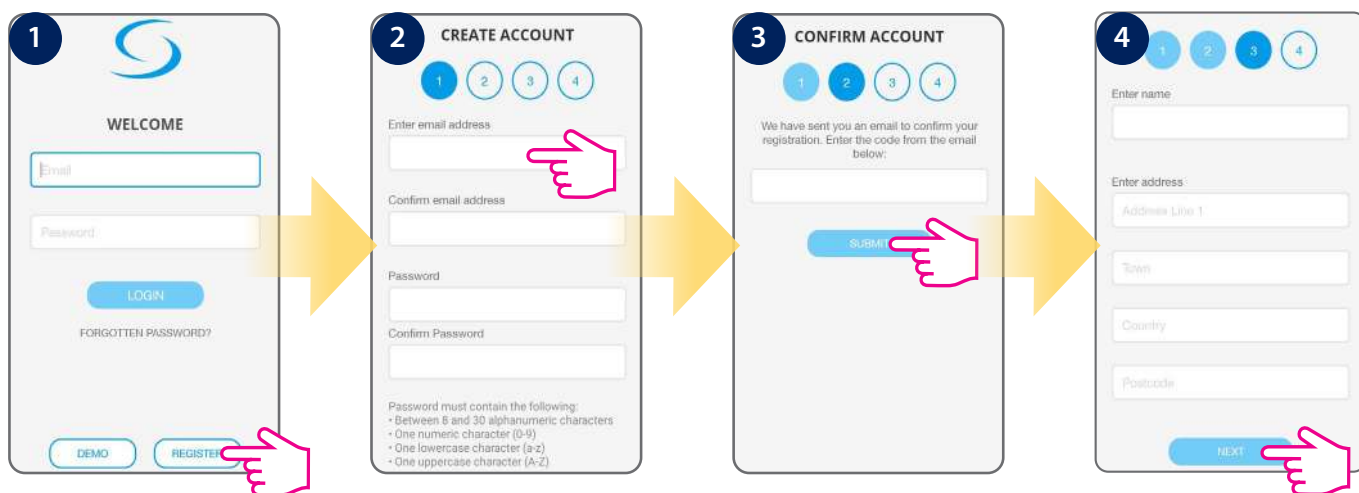

Tap register to create a new account.

Enter email and password, tap Next.

Enter the code you received via email.

Fill all forms and tap Next.

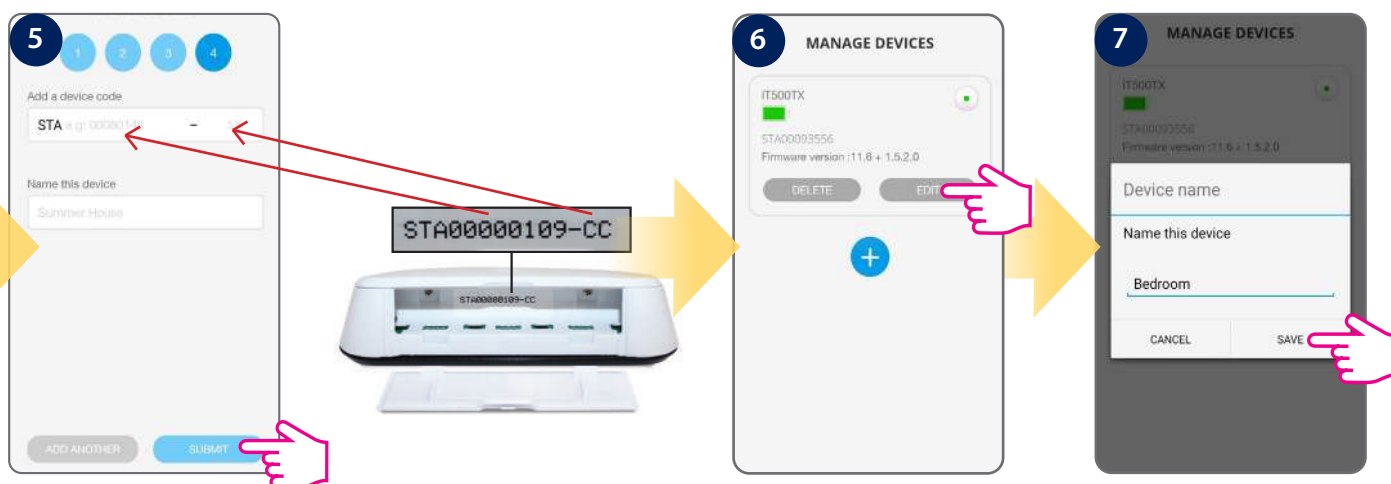

Enter the STA device code (look at the picture how) and name your thermostat (max. 11 characters). Tap Submit.

Please refer to chapter 3.4 how to find STA device code.

Your device appears on the screen. Tap Edit to rename it.

Name the device (max. 11 characters) and tap Save.

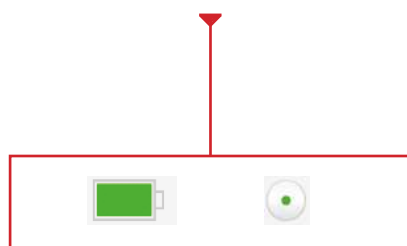

Green full battery icon means that battery is good. When this icon turns red, then you should change the batteries.

Green dot mark means that thermostat is connected with the app. When dot goes grey, then thermostat is out of the network.





Tap anywhere on tile to enter the thermostat interface.

Thermostat interface in schedule mode.

When the thermostat is connected to the App, the  icon will appear on the App screen and the  icon will appear on the thermostat screen.

For easier start you can use app "Tutorial", which is available in the menu. Please see steps below:



Tap menu icon.

Select "Tutorial".

Follow presented instructions.

## 6. Operating in ONLINE MODE (by app)

### 6.1 General informations

When you first enter the application thermostat will automatically display settings page to force on the user to enter main parameters (such as time zone, operation algorithm, heat/cool mode etc.) Then app will go to home screen and will display the room temperature and setpoint temperature (it will operate in Manual mode as default).

#### Features available on the App:

- Clock format
- Time zone
- Daylight Saving Time
- Heating or Cooling Mode
- Temperature accuracy
- Display tolerance
- Temperature offset
- Schedule/Manual/Off Mode
- Holiday Mode
- Frost Mode

### 6.2 App interface of the thermostat for heating zone



### 6.3 App interface of the thermostat for DHW control

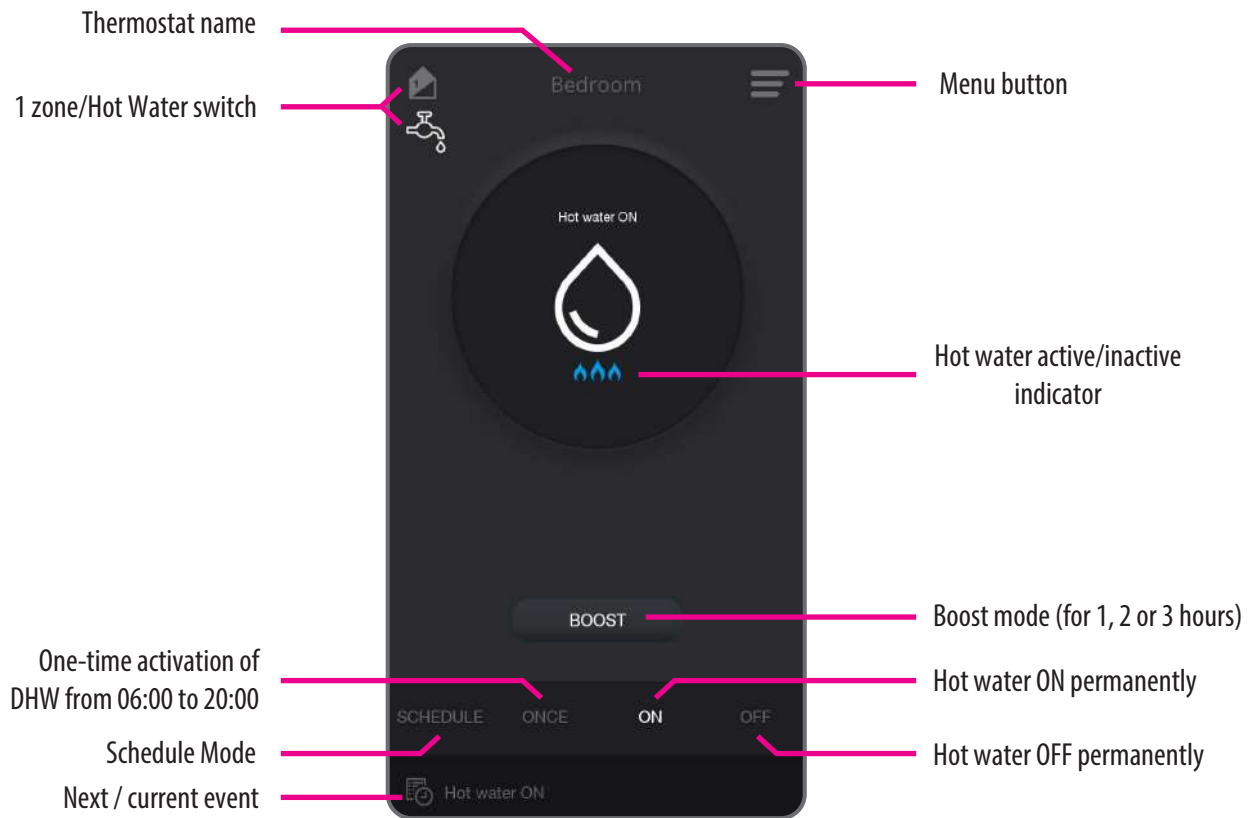

## 6.4 Thermostat modes

### 6.4.1 Schedule mode for heating zone

Switch to Schedule Mode to programm a schedule. Note that there are 3 types of schedules. Each schedule consist 6 time intervals:

- 5+2 (separate schedule for working days and separate schedule for weekends)
- INDIVIDUAL (separate schedules for each day)
- ALL (one schedule for whole week)

1 Tap schedule.

2 Tap Arrow.

3 Select Type: 5+2.

3a All/Individual.

3b All/Individual.

4 Tap first interval.

5 Adjust time.

6 Adjust temperature.

7 Tap Save.

8 Tap next time interval.

9 Follow the same procedure.

You need to follow the same steps for all intervals and all days in order to set schedules for the weekend days. Also, you can copy the schedules from one day to another, which comes very handy if you are setting your days individually. Please see below to see how to copy the schedules from one day to another.

1 Select day.

2 Tap Copy.

3 Copied day will be marked with blue. Tap the day you want to paste into.

3a Tap Paste.

4 Schedule is saved.

## 6.4.2 Schedule mode for hot water system

For hot water system there are 3 types of schedules. Each schedule consist 6 time intervals:

- 5+2 (separate schedule for working days and separate schedule for weekends)
- INDIVIDUAL (separate schedules for each day)
- ALL (one schedule for whole week)

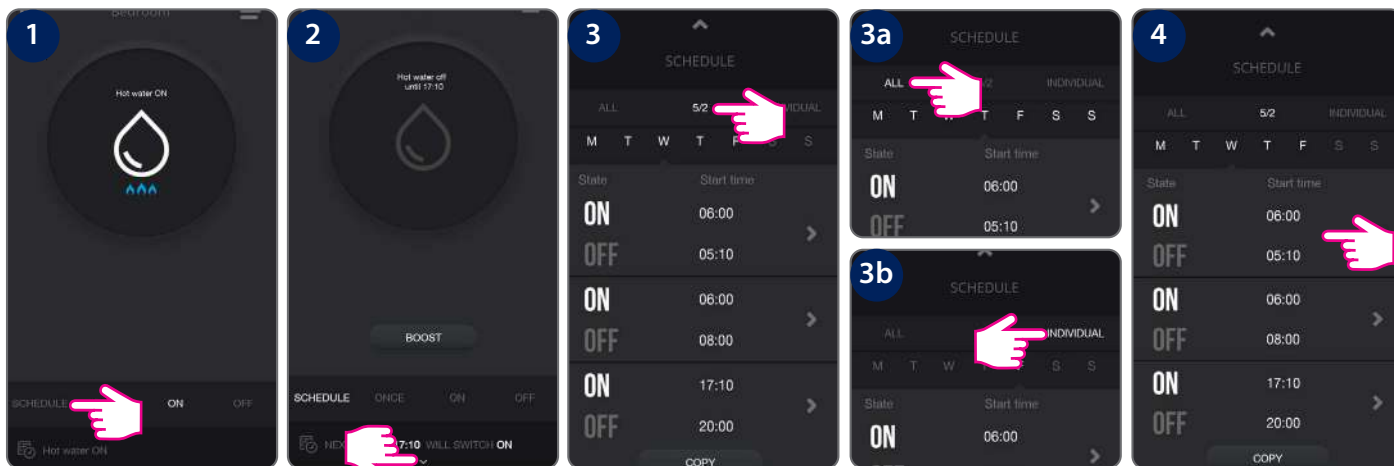

Tap schedule.

Tap Arrow.

Select Type: 5+2.

All/Individual.

Tap first interval.

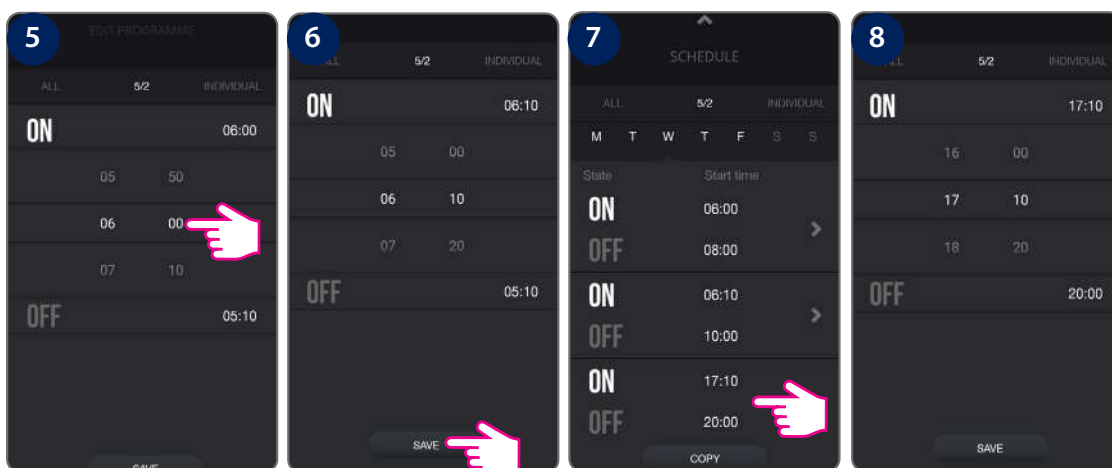

Adjust time.

Tap Save.

Tap next time interval.

Follow the same procedure.

You need to follow the same steps for all intervals and all days in order to set schedules for the weekend days. Also, you can copy the schedules from one day to another, which comes very handy if you are setting your days individually. Please see below to see how to copy the schedules from one day to another.

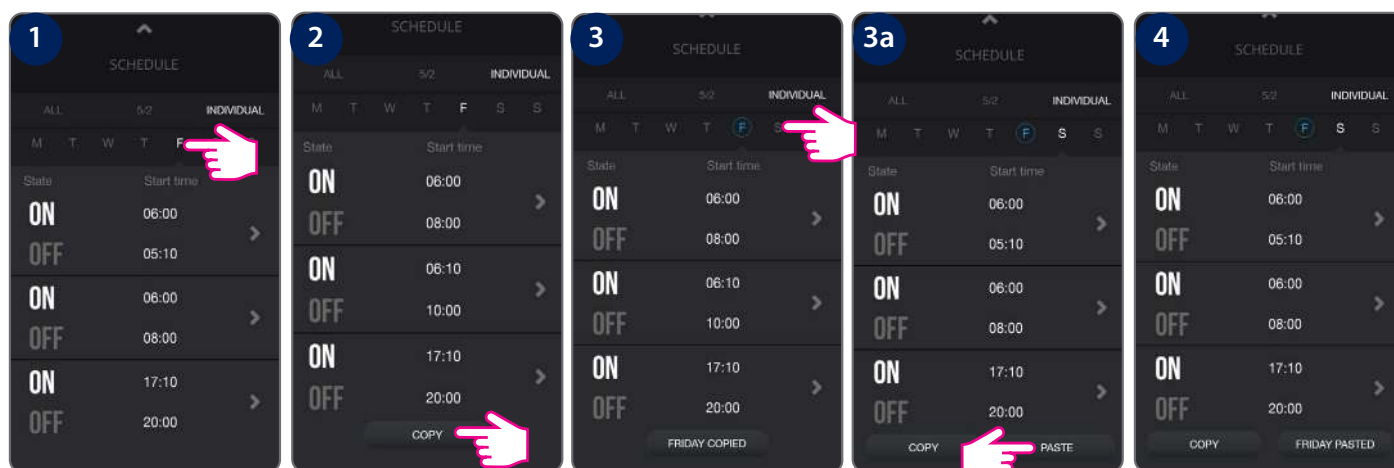

Select day.

Tap Copy.

Copied day will be marked with blue. Tap the day you want to paste into.

Tap Paste.

Schedule is saved.

### 6.4.3 Temporary override mode

To temporarily override a setpoint temperature, thermostat must be in schedule mode. Set new setpoint temperature using slide button. Thermostat will keep new setpoint until the next change forced by schedule. See the pictures below:



Change the temperature setpoint during active schedule mode.



Thermostat has temporary overridden the temperature until next schedule change.

### 6.4.4 Manual mode

In manual mode, thermostat maintains a constant temperature set by the user. The temperature can be changed both from the application or device. To exit manual mode select e.g. schedule mode or OFF mode (frost protection).



Set the temperature setpoint.



In manual mode thermostat will maintain set temperature until user won't change it again.

## 6.4.5 Frost protection mode

In **frost protection mode** the thermostat is displaying actual room temperature and maintain „frost protection” setpoint temperature specified in thermostat settings. When thermostat works in frost protection mode then you have no possibilities to change temperature setpoint. To activate Frost protection mode online please follow steps below:

### Frost Protection ON



1 Tap frost protection mode button.

2 Thermostat is in the frost protection mode.

### Frost Protection OFF



1 Tap manual mode button.

2 Thermostat is in the manual mode (switched from frost protection mode).

## Frost Protection Setpoint

You can adjust the Frost Protection setpoint using the App. The setpoint range is between 5-9°C.

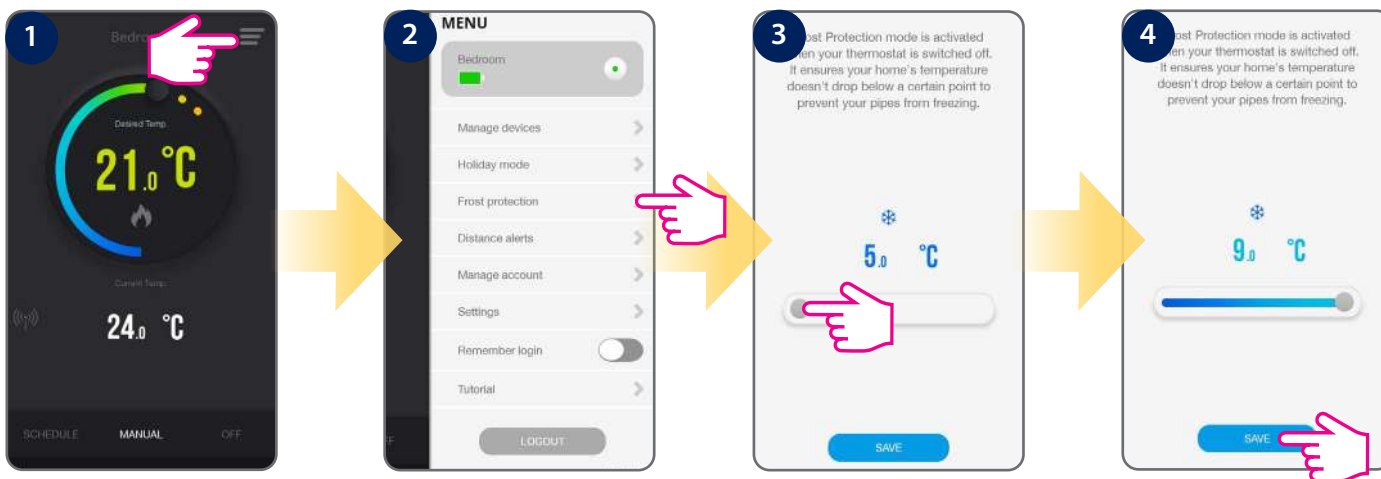

1 Tap menu icon.

2 Go to Frost Protection.

3 Adjust temperature. Default is 5°C.

4 Tap Save.

## 6.5 Thermostat app settings

### 6.5.1 Clock format, time zone and DST setting



**Note:** Time and date will be automatically added once you connected to the internet. What you have to do manually, though, is to select your temperature format, clock format and time zone. This can be easily done by following these steps:



Tap menu icon.

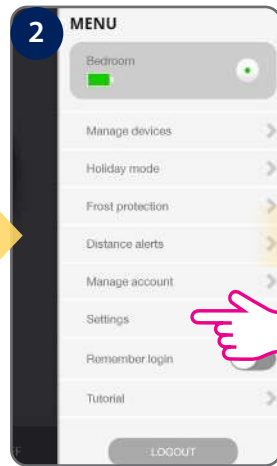

Go to settings.

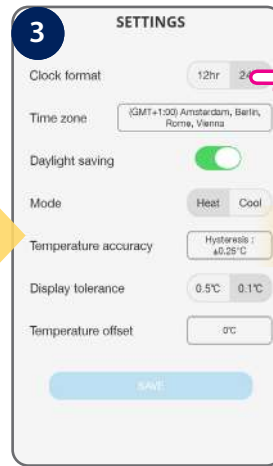

Select clock format.

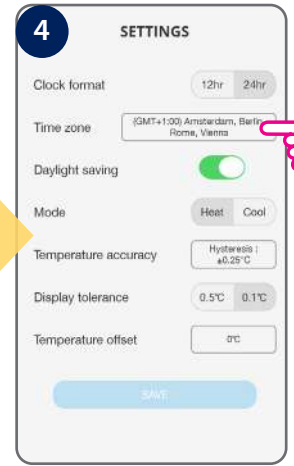

Select time zone.



DST (Daylight Saving Time)  
ON/OFF.

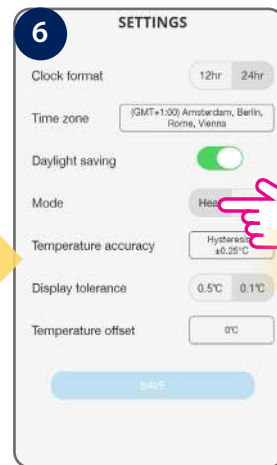

Select Heat or Cool mode.

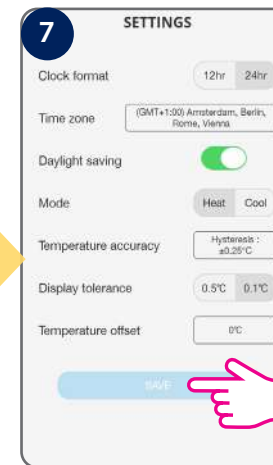

Tap Save.

After you adjust all of your settings, tap Save. The app will then return to the home screen where you can start adding programs.



## 6.5.2 Heat/Cool mode change (app)

IT500 thermostat can be used for heating systems or for cooling systems. Heating mode is default but there is possible to change mode to cooling. Before mode change make sure your system is appropriately adjusted.

### Changing to Cool Mode



Tap menu icon.

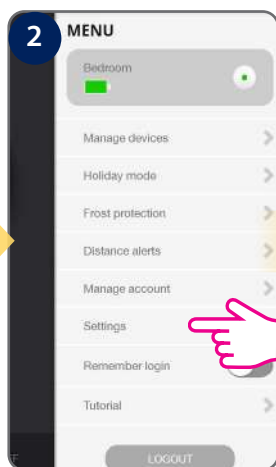

Go to settings.

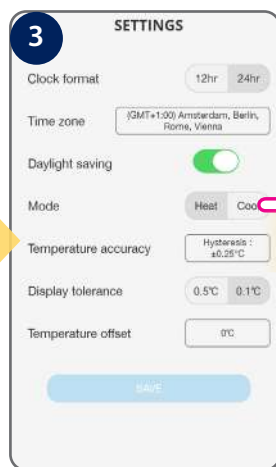

Select Cool Mode.

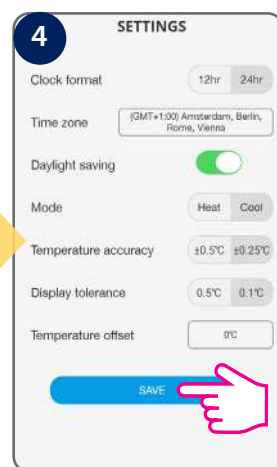

Tap Save.



Using the cursor, set the temperature.



The frost icon will turn blue and animated meaning thermostat is calling for cooling.



The fan icon will appear on the LCD next to house icon, meaning thermostat is calling for cooling.

## Changing to Heat Mode



Tap menu icon.

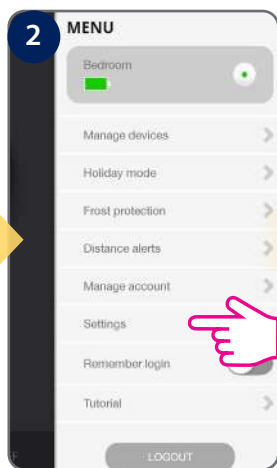

Go to settings.

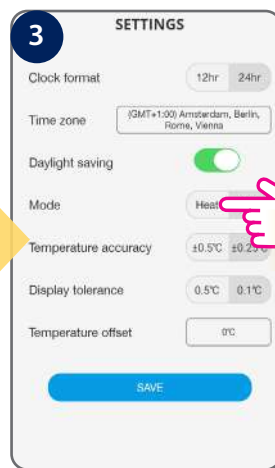

Select Heat Mode.

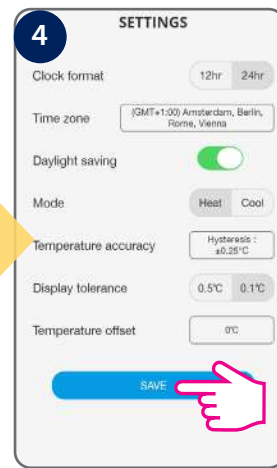

Tap Save.



Using the cursor, set the temperature.



The Flame icon will turn orange and animated meaning the thermostat is calling for heat.

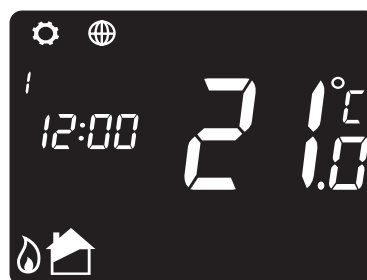

The heat mode icon will appear on the LCD next to house icon, meaning that thermostat is calling for heat.

### 6.5.3 Holiday mode

You can set your iT500TR to holiday mode. During this mode, the thermostat will run like in Frost Protection Mode but for specified amount of time. When activated, a suitcase icon appears on the display of your device. You can set Holiday mode from the App only. It can be set for maximum 31 days.

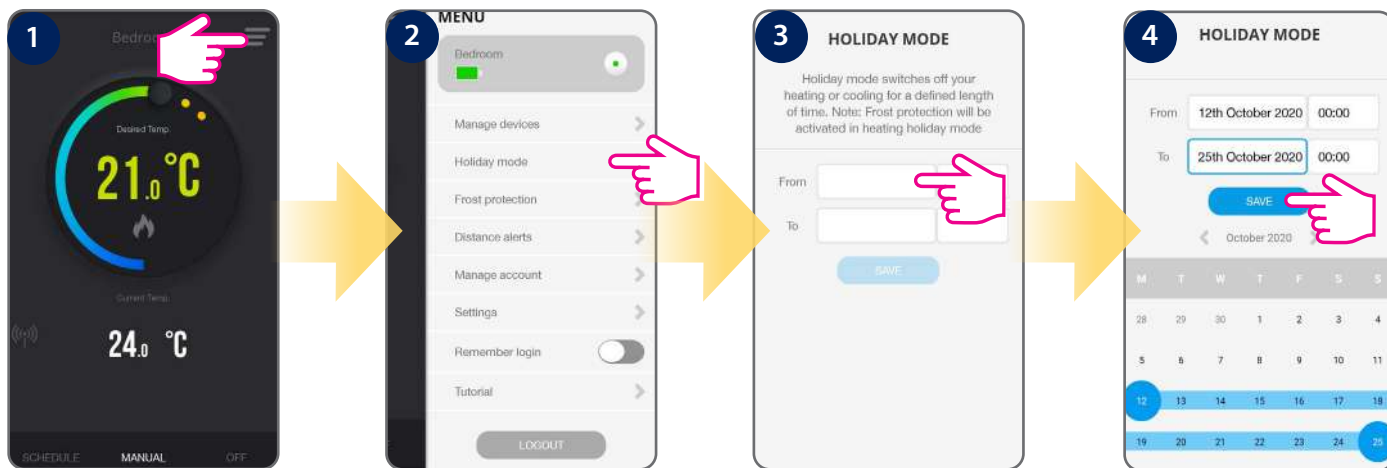

Tap menu icon.

Go to Holiday Mode.

Enter holiday dates with hours and minutes.

Tap Save.

### 6.5.4 Distance alerts

It can be used as a reminder to turn OFF or turn ON heating in your house.

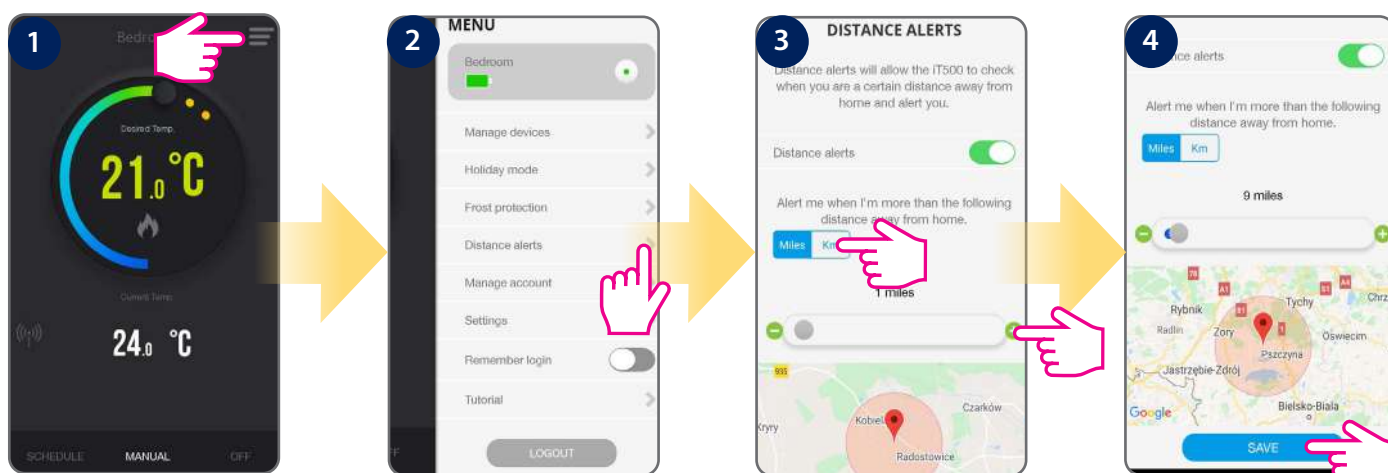

Tap menu icon.

Go to distance alerts.

Choose miles/km and set a distance.

Tap Save.

You can also choose to deactivate distance alerts in one easy step.

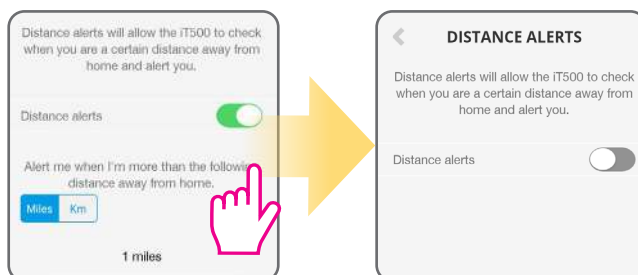

**Note!!!** Proper operation of this function depends on the Internet provider, location function possibilities of the smartphone/tablet, range and background activity of the application.

## 6.5.5 Factory Reset (removing thermostat from the app)

To make thermostat factory reset and remove it from the iT500 Plus App please follow steps below:

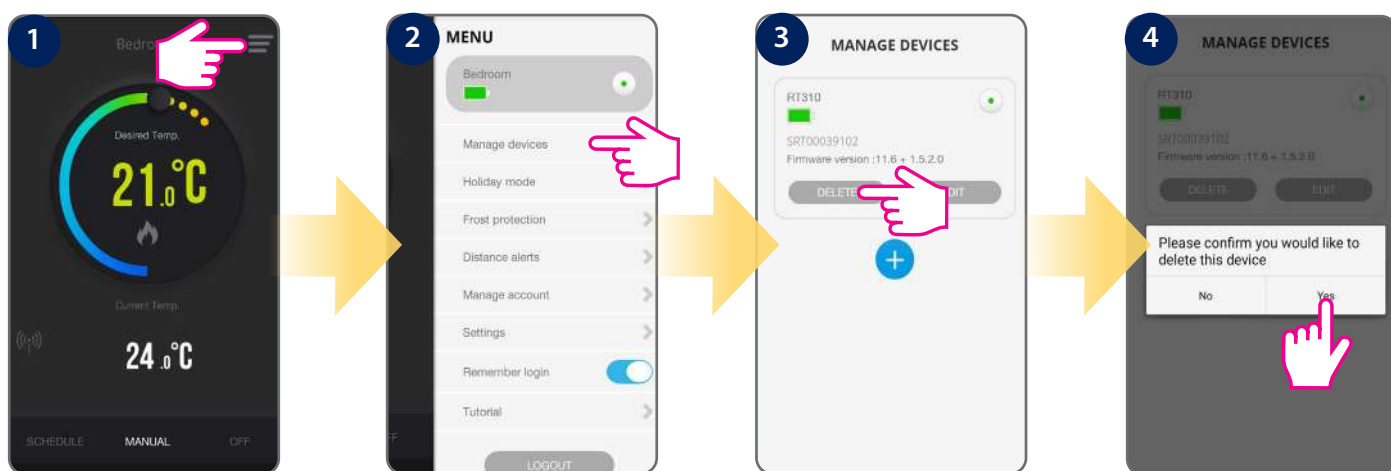

Tap menu icon.

Go to Manage devices.

Tap delete.

Tap Yes.

After that you will need to add and set your thermostat all over again.

## 7. Installation in OFFLINE MODE

### 7.1 Identify your system type

The system type is individually adjusted to your system configuration. It will be set by your installer and should only be changed by your installer.



**1** One central heating zone only.



iT500 Display



Smartphone Display  
(ONLINE MODE)



**2** Two central heating zones.



iT500 Display



Smartphone Display  
(ONLINE MODE)



**3** One central heating zone plus hot water.



iT500 Display



Smartphone Display  
(ONLINE MODE)

## 7.2 System configuration selection

 This menu should only be entered by the installer as changes can have a detrimental effect on your heating system.

 At any time press  for return to the previous step or hold  for 5 seconds to return to the home screen.



Press the power button ① to highlight the display.

Press and hold  and  buttons for 3 sec.

Press  button to confirm.

Press  or  button to select your system configuration. To confirm press  button.



One central heating zone.



Two central heating zones.



One central heating zone + hot water system.



or

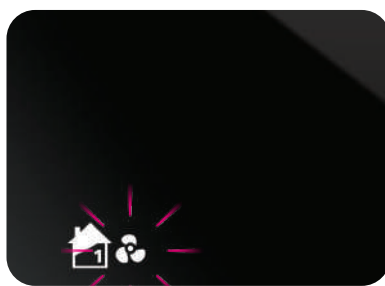

or

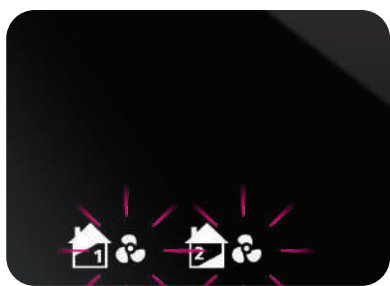

or



Press  or  button to select heating  or cooling\*  mode. Press  button to confirm.  
\*Cooling can only be selected if your system supports this.

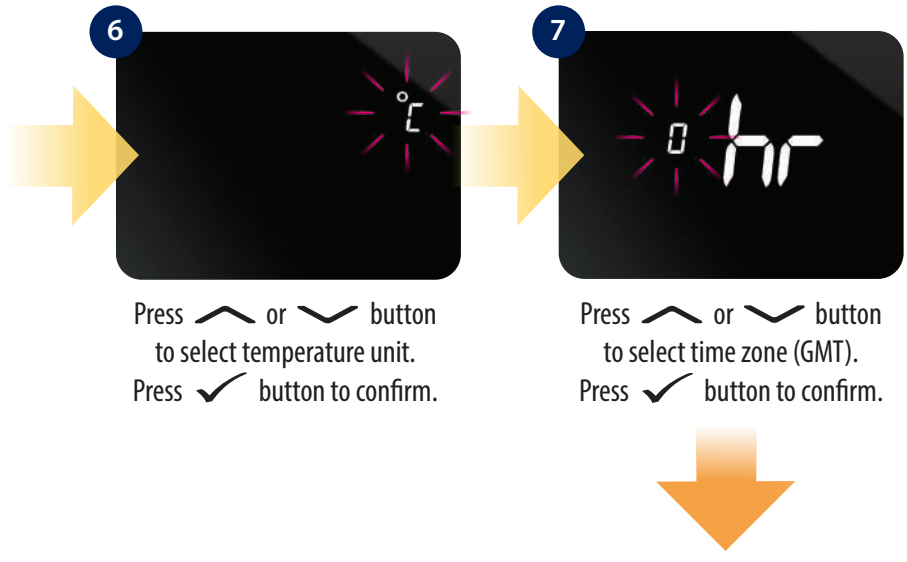

GMT	GMT+1 Hour	GMT+2 Hour	GMT+3 Hour
UK IRELAND PORTUGAL ICELAND*	AUSTRIA POLAND GERMANY CZECH SPAIN FRANCE ITALY SWITZERLAND LUXEMBOURG HOLLAND BELGIUM DENMARK SWEDEN NORWAY MALTA CROATIA SERBIA BOSNIA SLOVENIA SLOVAKIA	ESTONIA TURKEY CYPRUS GREECE ROMANIA RUSSIA UKRAINE BULGARIA LITHUANIA BELARUS* FINLAND MOLDOVA LATVIA	RUSSIA*

The countries marked with \* do not observe Daylight Saving Time. For details please see below.



DST (Daylight Saving Time) ON will automatically change your time from summer to winter.

Press or button to turn ON or OFF day saving time function.  
 Press button to confirm.

## 8. Operating in OFFLINE MODE

### 8.1 Operating modes

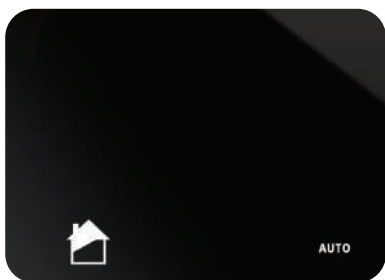

**AUTO** - automatic mode  
(works according to the schedule)

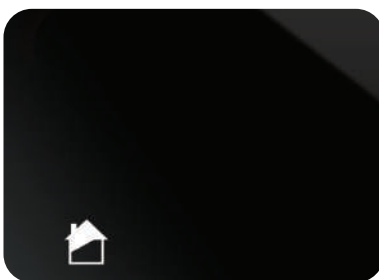

**Permanent manual mode**

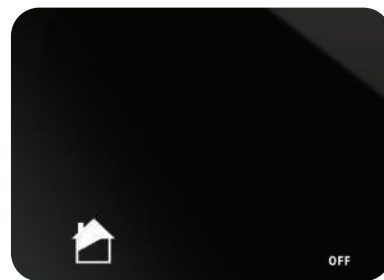

**OFF** - antifrost mode 5°C  
(changing temperature is available only through the app)



### 8.2 Setpoint temperature change (manual mode)

iT500TR is in manual mode by default. To change setpoint temperature please look at the steps below:



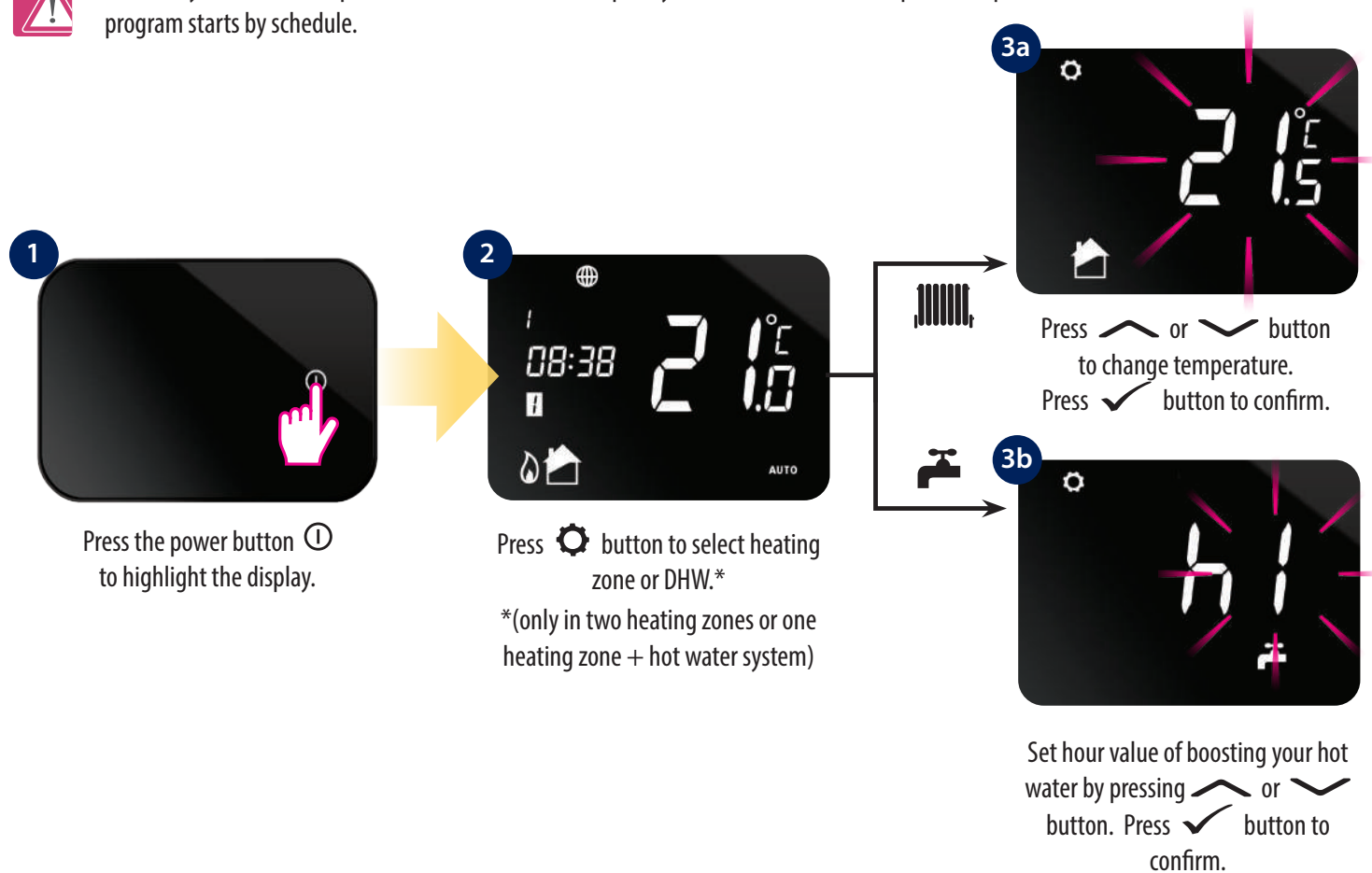

**Note:** If you set the temperature in AUTO mode (temporary override), then new setpoint temperature will be maintained until the next program starts by schedule.







## 8.3 Schedule mode

### 8.3.1 Schedule mode for heating zone

 You can easily set your schedule via iT500 Plus app . If you want to set schedules directly by the iT500 thermostat, please follow the instruction below.

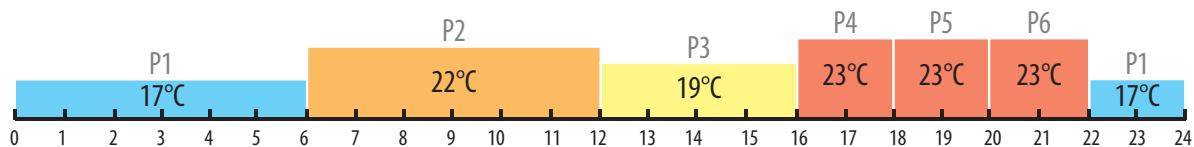
In iT500 thermostat you can define 6 schedule programs per day. You can set different temperature level for each program. While programming specific time interval you must be aware that you are about to set at what time the program will start. For example, if you set program 1 for 6:00 (AM) it means the program is going to run at 6:00 (AM) and will running till the time set for next program. Example of 4 temperature levels for 6 schedule programs:



 **Note:** When you set program schedule, necessarily set all 6 programs. I.e. if you want to set 2 temperature levels, you need to set first temperature level for 1 to 5 program and set second temperature level only for program 6.



Press the power button ① to highlight the display.

Press and hold ⚙ button for 3 seconds.

Press ✓ button to confirm.

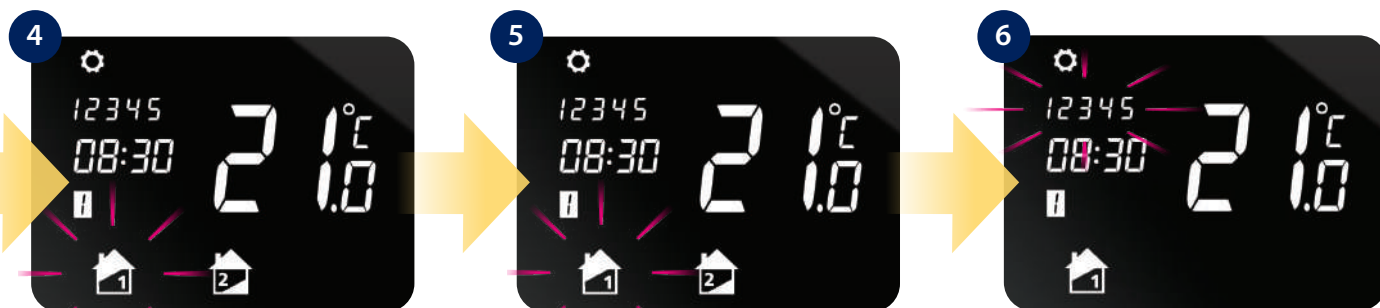

Press ⚙ button to select temperature zone.\*  
\*(only in two heating zones)

Press ✓ button to confirm.

Press ⚙ button to choose ALL, 5/2 or INDIVIDUAL days.  
Press ✓ button to confirm.

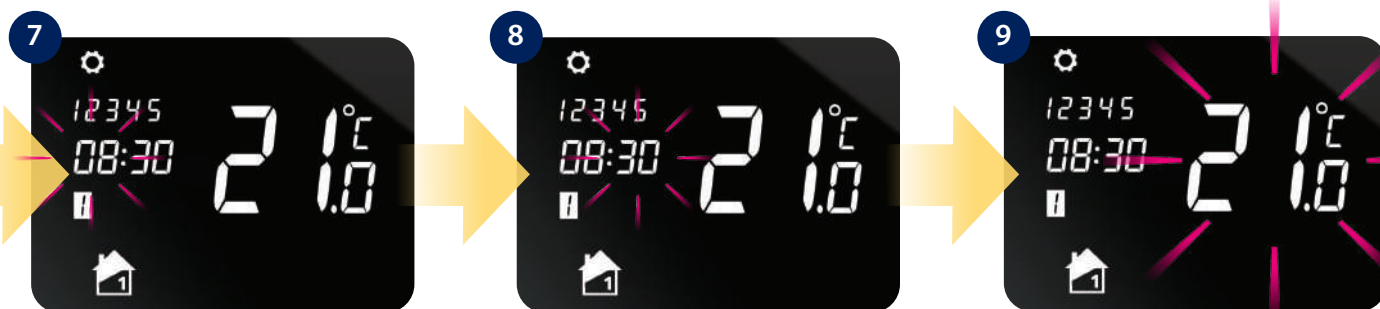

Press ^ or v button to set start hour for program 1.  
Press ✓ button to confirm.

Press ^ or v button to set start minutes for program 1.  
Press ✓ button to confirm.

Press ^ or v button to set temperature level for program 1.  
Press ✓ button to confirm. Follow the steps 7-9 to set next programs.

### 8.3.2 Schedule mode for hot water system



**Note:** In program schedule for hot water system (HW)  you can set 3 schedule programs per day. For each HW program you must define the time of start and the time of the end.

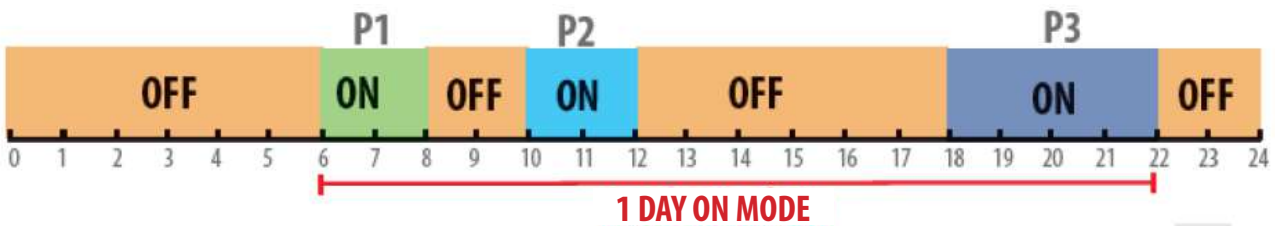

- 1** 

Press the power button  to highlight the display.
- 2** 

Press and hold  button for 3 seconds.
- 3** 

Press  button to confirm.
- 4** 

Press  button to select hot water system .
- 5** 

Press  button to confirm.
- 6** 

Press  button to choose ALL, 5/2 or INDIVIDUAL days.  
Press  button to confirm.
- 7** 

Press  or  button to set start hour for program 1.  
Press  button to confirm.
- 8** 

Press  or  button to set start minutes for program 1.  
Press  button to confirm.
- 9** 

Set time for turn OFF program 1 cognately to step 7-8.  
Press  button to confirm.  
Follow the steps 7-9 to set next programs.

### 8.3.3 Default schedules

Your iT500 comes with pre-set default program schedules like shown below.

#### Central Heating

PROGRAM	WEEKDAY (1 to 5)	WEEKDAY (6 to 7)
1	Time 22:00pm Setpoint Temp 17°C	Time 22:00pm Setpoint Temp 17°C
2	Time 6:00am Setpoint Temp 22°C	Time 6:00am Setpoint Temp 22°C
3	Time 12:00pm Setpoint Temp 19°C	Time 12:00pm Setpoint Temp 19°C
4	Time 4:00pm Setpoint Temp 23°C	Time 4:00pm Setpoint Temp 23°C
5	Time 6:00pm Setpoint Temp 23°C	Time 6:00pm Setpoint Temp 23°C
6	Time 8:00pm Setpoint Temp 23°C	Time 8:00pm Setpoint Temp 23°C

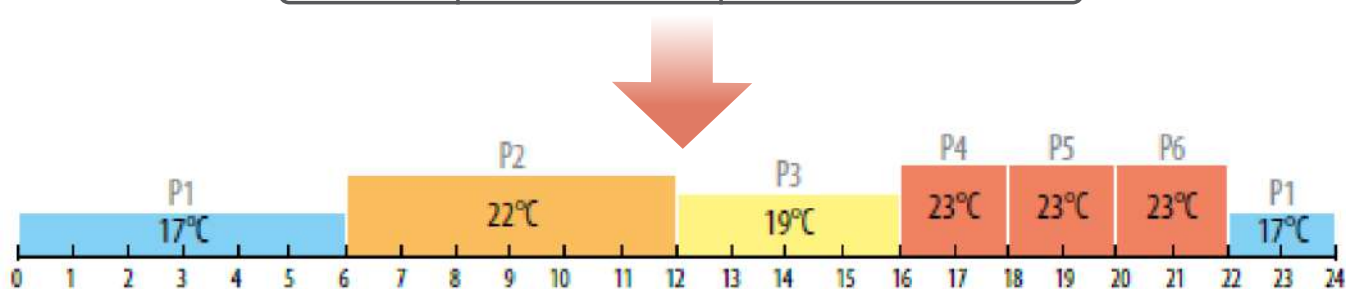

#### Hot Water

PROGRAM	OP	WEEKDAY (1 to 5)	WEEKDAY (6 to 7)
1	ON OFF	6:00am 8:00am	6:00am 8:00am
2	ON OFF	10:00am 12:00pm	10:00am 12:00pm
3	ON OFF	6:00pm 10:00pm	6:00pm 10:00pm

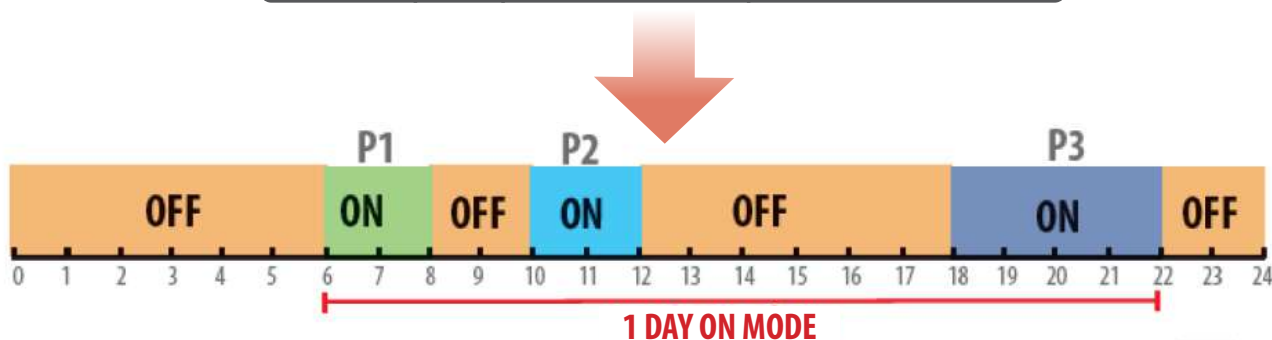

## 8.4 Temporary override mode

When thermostat is running schedule mode we can temporarily override it by setting new setpoint temperature.



Temperature will be overridden until the next program change. You can cancel temporary override by holding button for 3 seconds. Setting indicator should disappear.

## 8.5 Key lock function

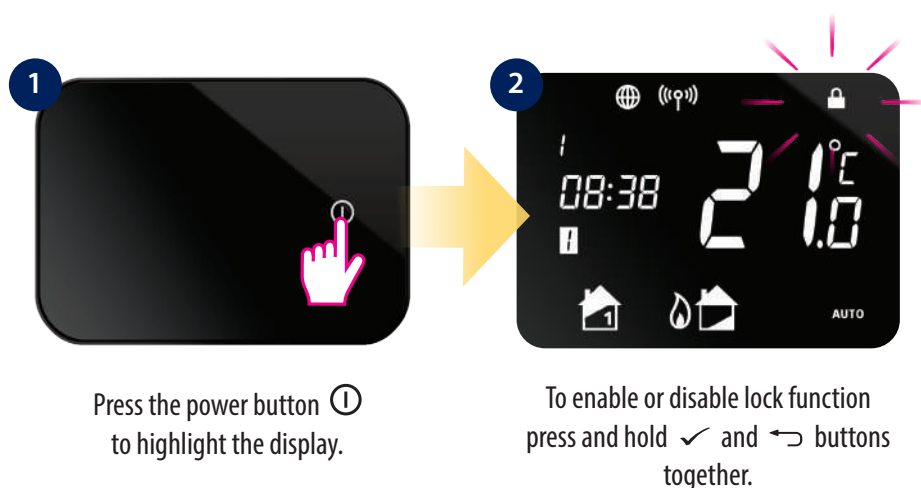

## 8.6 User settings

### 8.6.1 Setting the time and date

 When connected to the internet, the iT500 will set time and date automatically. However this can also be set manually.



Press and hold  button.

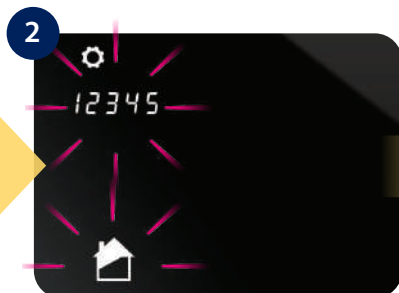



Press again  button to change value.



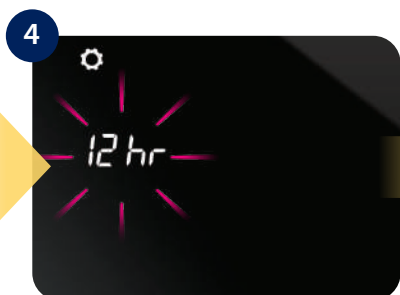

Press  button to confirm.



Press  or  button to set 12 or 24 hour format. Press  button to confirm.



Press  or  button to set the hour. Press  button to confirm.

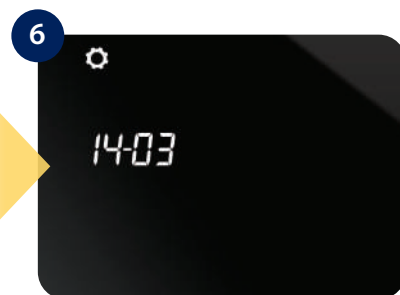

Follow the same steps to set the minutes, day, month and year.

### 8.6.2 Heat/Cool mode change

iT500TR thermostat can work in heating or cooling mode. To set thermostat operating mode please follow steps below:



Press the power button  to highlight the display.





Press and hold  and  buttons for 3 sec.



Using  button search heat/cool mode option. Confirm by  button.



Use  or  buttons to change mode. Confirm selected mode by  button.



Thermostat will go to the next setting. Hold  button to exit to main screen.

### 8.6.3 Time zone selection

Assign the proper time zone to your thermostat.

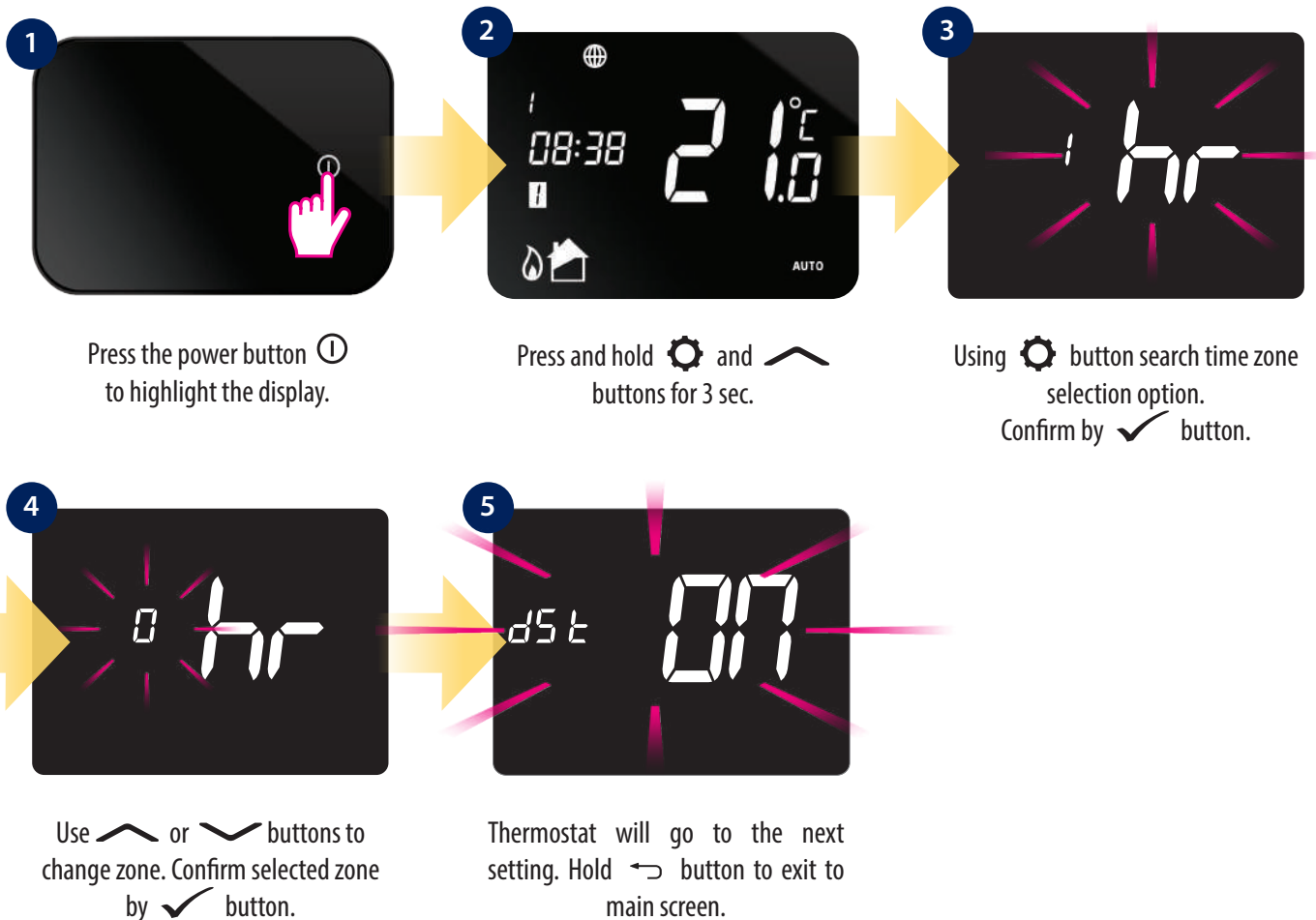

### 8.6.4 Daylight Saving Time setting

Set the DST setting ON or OFF (it's mostly for economic thermostat work).

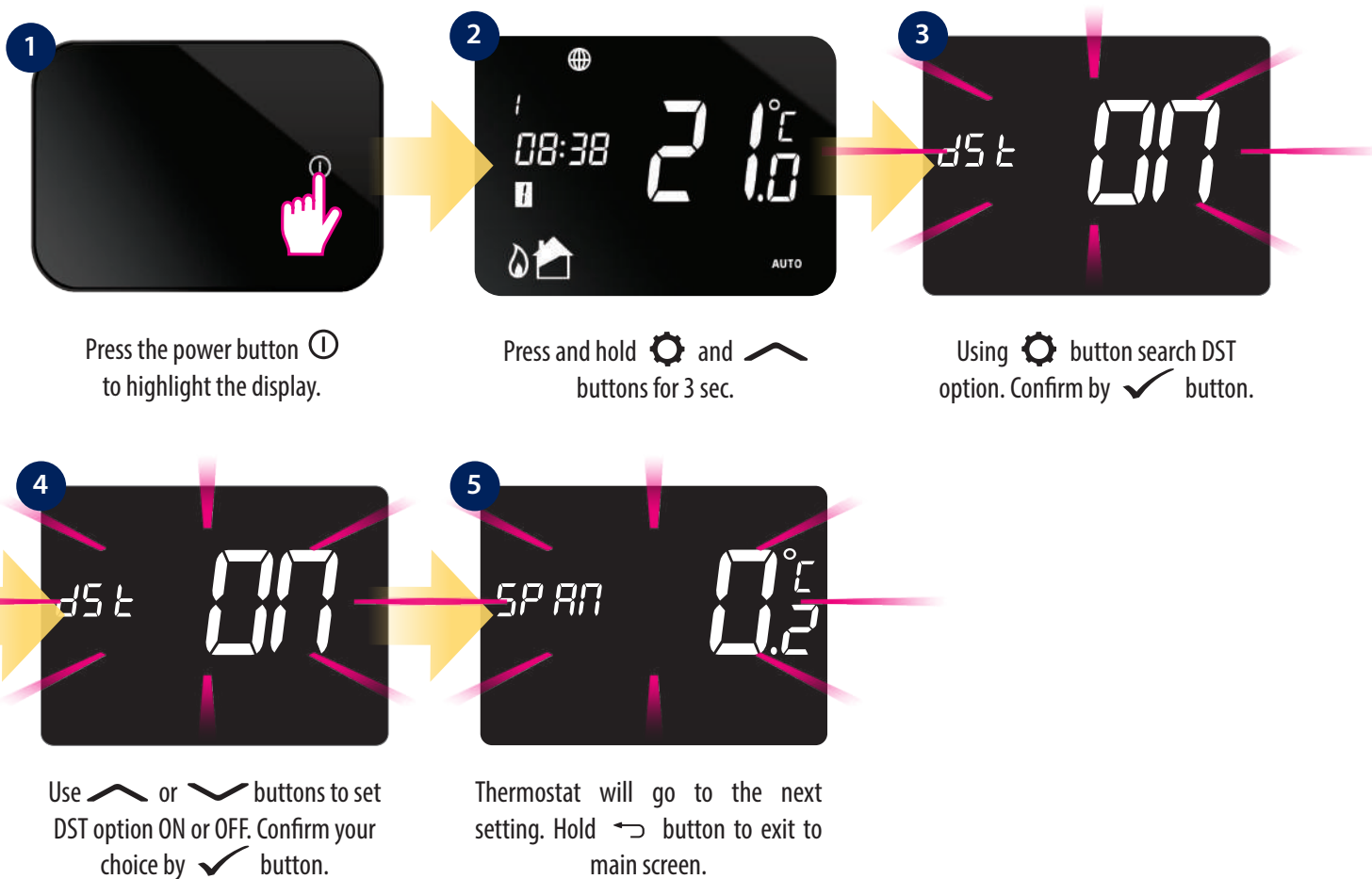

### 8.6.5 Hysteresis (SPAN) setting

To set the proper hysteresis value, please follow steps below:

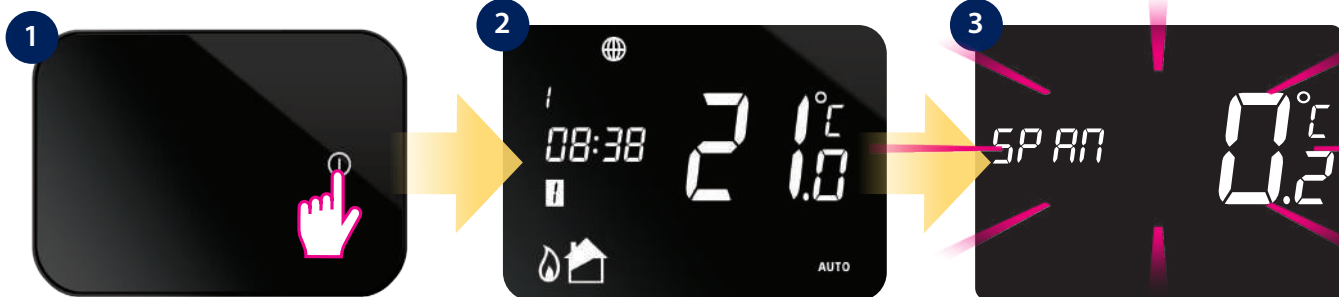



Press the power button  to highlight the display.

Press and hold  and  buttons for 3 sec.

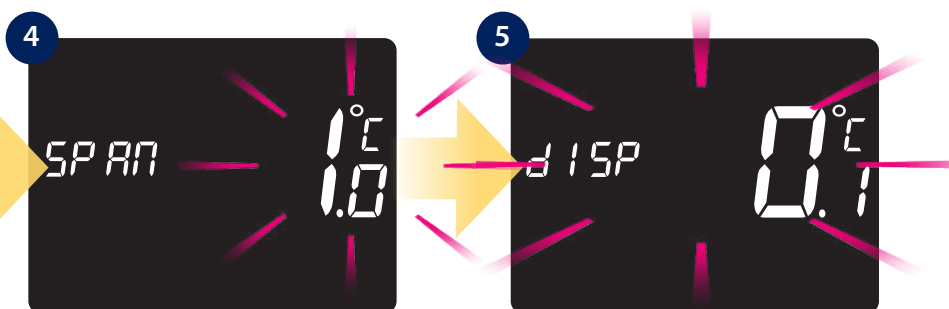
Using  button search SPAN option. Confirm by  button.



Use  or  buttons to set hysteresis value. Confirm your choice by  button.

Thermostat will go to the next setting. Hold  button to exit to main screen.

### 8.6.6 Display temperature accuracy

Adjust the measured thermostat temperature to the environment. Please follow steps below:





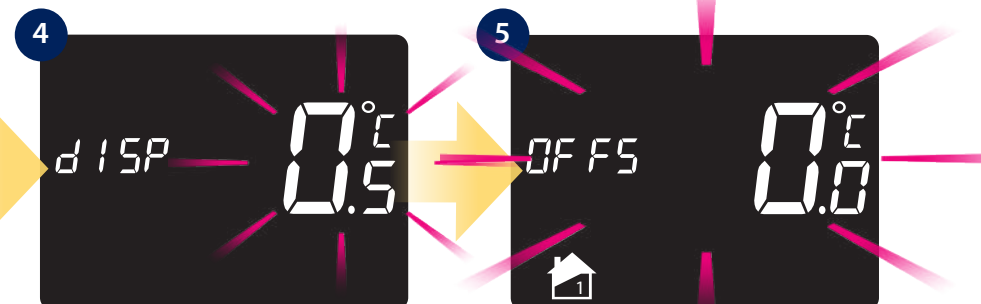

Press the power button  to highlight the display.

Press and hold  and  buttons for 3 sec.

Using  button search display temperature accuracy option. Confirm by  button.



Use  or  buttons to set display accuracy value. Confirm your choice by  button.

Thermostat will go to the next setting. Hold  button to exit to main screen.

### 8.6.7 Thermostat calibration (OFFS)

Thermostat calibration is a function which allows user to recalibrate internal thermostat's temperature sensor by a given number of degrees (in the range from -3,0 °C to 3,0 °C in 0,5 °C steps). To calibrate thermostat's temperature sensor please follow steps below:





Press the power button  to highlight the display.



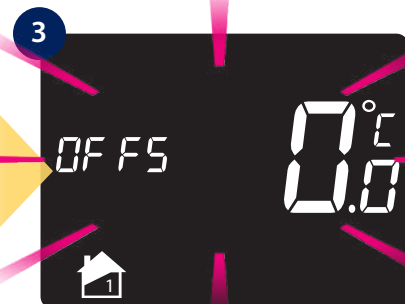

Press and hold  and  buttons for 3 sec.



Using  button search thermostat calibration option. Confirm by  button.



Use  or  buttons to set temperature calibration value. Confirm your choice by  button.

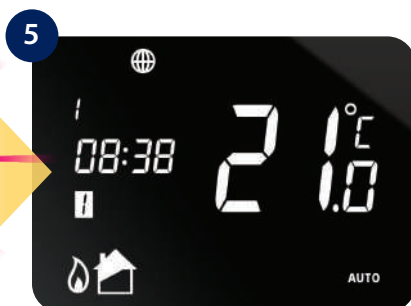

Thermostat will go back to the main screen.

### 9. Error codes

Error code will appear only when iT500TR thermostat is set for two zones operation and iT300 sensor is not paired or distance between iT500 and iT300 is too big and connection is broken. The following error will then be displayed on the thermostat screen and in the app:

DEVICE VIEW:

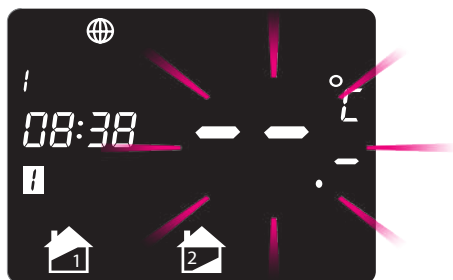

APP VIEW:



To solve it, you have to pair iT300 thermostat and set the two zone thermostat operation mode again. Error will disappear.



## 10. Temperatures outside operating range

Temperatures below 10 °C are displayed without the leading '0'. Temperatures exceeding the measurable range will be indicated by 'HI' for temperatures above the upper limit, and 'LO' for temperatures below the lower limit, as shown in the images.

### Thermostat view:

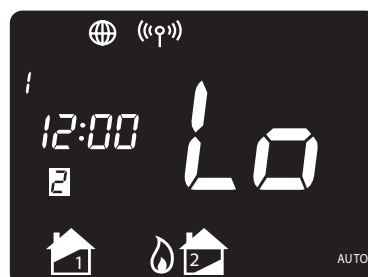
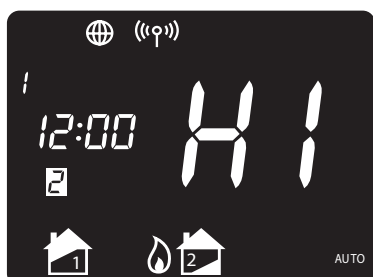

### App view („Lo" example):



## 11. Failsafe mode

In the event of loss of the radio signal between the thermostat and the receiver, the system will automatically switch to emergency mode. In the emergency mode, the iT500RX receiver is turned on for 4 minutes, and turned off for 11 minutes. The emergency mode is activated only when the receiver slider is in the AUTO position and the loss of connection between devices lasted at least 1 hour. To deactivate the receiver's emergency mode, move the slider to the OFF or MANUAL position.

## 12. Cleaning and Maintenance

The **iT500TR thermostat** requires no special maintenance. Periodically, the outer casing can be wiped clean using a dry cloth (please DO NOT use solvents, polishes, detergents or abrasive cleaners, as these can damage the thermostat). There are no user serviceable parts within the unit; any servicing or repairs could only be carried out by **Salus Controls** or their appointed agents.

## 13. Technical Informations

Power supply	iT500TR: 2 x AA batteries iTG500: 5V DC iT500RX: 230V AC 50 Hz
Rating max	CH1: 16(5) A CH2: 5(3) A
Output	2 x NO/COM/NC relay
Temperature range	5°C – 35°C
Display temperature accuracy	0.1°C or 0.5°C
Control algorithm	TPI or Hysteresis: $\pm 0.25^\circ\text{C}$ , $\pm 0.5^\circ\text{C}$ , $\pm 1^\circ\text{C}$ or $\pm 2^\circ\text{C}$
Communication	Wireless, 868Mhz
Dimension [mm]	iT500TR: 95 x 128 x 30 iTG500: 91 x 39 x 25, antenna: 70 iT500RX: 100 x 145 x 35

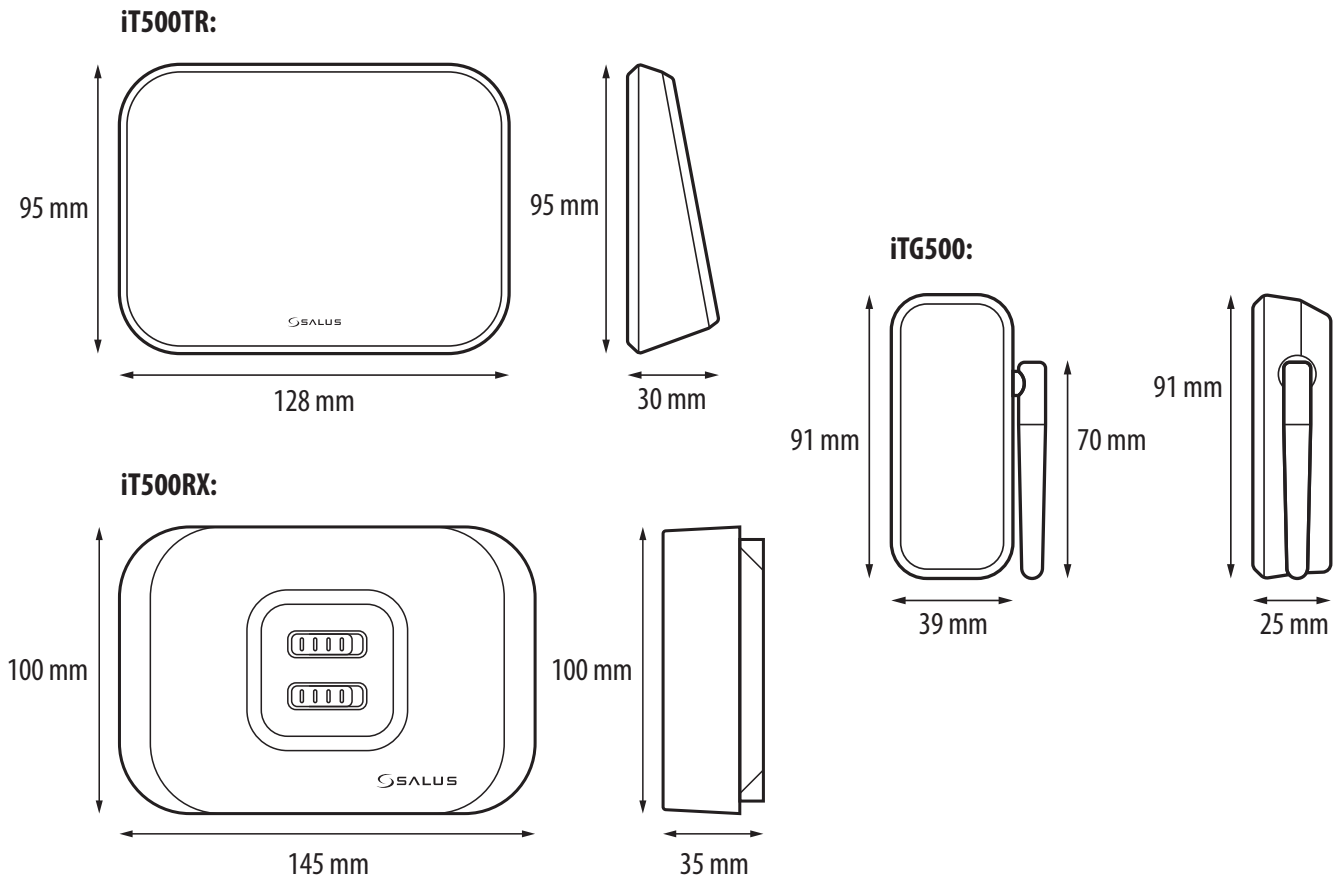

## 14. Warranty

SALUS CONTROLS warrants this product to be free from any defects in material or workmanship and to perform as specified for a period of five years from the date of installation. SALUS CONTROLS reserves the sole responsibility for breach of this warranty by repairing or replacing the defective product. This product includes software that matches the distributor's identification at the time of sale. The manufacturer / distributor provides a guarantee covering all functions and specifics of the product in accordance with this marking. The distributor's warranty does not cover the correct operation of the functions and features available as a result of a product software update.

The full warranty conditions are available at [www.salus-controls.eu](http://www.salus-controls.eu)

Customer Name: .....

Customer Address: .....

..... Post Code: .....

Tel No: ..... Email: .....

Company Name: .....

Tel No: ..... Email: .....

Installation Date: .....

Installer Name: .....

Installer Signature: .....

IMPORTER:

QL CONTROLS Sp. z o.o. Sp. k.  
ul. Rolna 4, 43-262 Kobielice

PRODUCER:

Salus Limited  
6/F, Building 20E, Phase 3, Hong Kong Science  
Park, 20 Science Park East Avenue, Shatin,  
New Territories, Hong Kong



[www.salus-controls.com](http://www.salus-controls.com)

SALUS Controls is a member of the Computime Group.

Maintaining a policy of continuous product development SALUS Controls plc reserve the right to change specification, design and materials of products listed in this brochure without prior notice.

Ver. 11

Issued: 31 III 2021

Soft version: 11.6

